

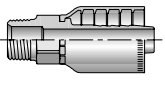

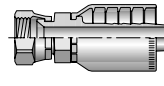

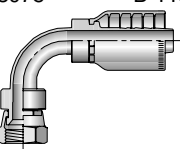





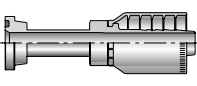
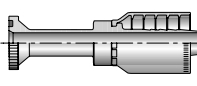
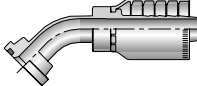
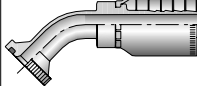
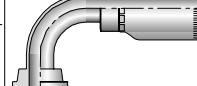
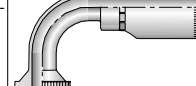
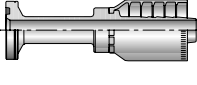
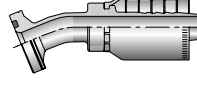
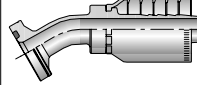
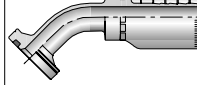
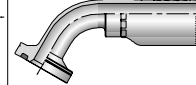

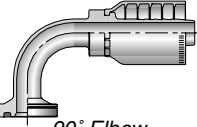

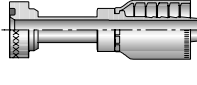
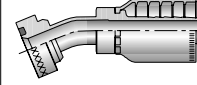
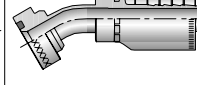
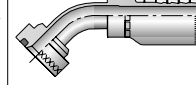
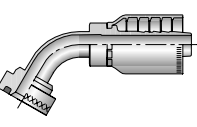
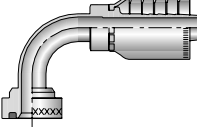

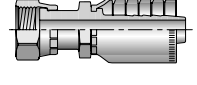
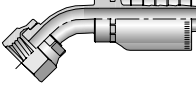
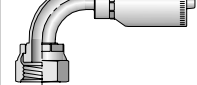

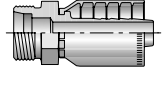

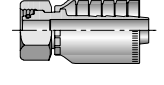
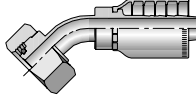
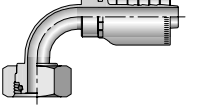

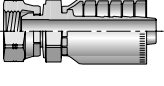
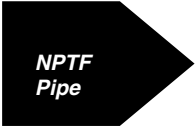
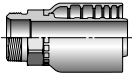

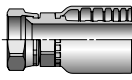
A		10178 B-118  Male - Rigid		10678 B-118  Female - Swivel	13978 B-118  Female - Swivel	
			 JIC 37°		 Code 61 Flange	
	11578 B-118  Flange	14A78 B-119  Flange (5000 psi)	11778 B-119  45° Elbow	14F78 B-119  45° Elbow (5000 psi)	11978 B-119  90° Elbow	14N78 B-120  90° Elbow (5000 psi)
		16A78 B-120  Flange	16B78 B-120  22-1/2° Elbow	16E78 B-120  30° Elbow	16F78 B-121  45° Elbow	16G78 B-121  60° Elbow
B		 Code 62 Flange				
	16N78 B-121  90° Elbow	 Caterpillar® Flange	1XA78 B-122  Flange	1XB78 B-122  22-1/2° Elbow	1XE78 B-122  30° Elbow	1XF78 B-123  45° Elbow
C						
	1XG78 B-123  60° Elbow	1XN78 B-123  90° Elbow	 Seal-Lok® (O-Ring Face Seal)	1JS78 B-124  Female - Swivel Long	1J778 B-124  Female - Swivel 45° Elbow	1J978 B-124  Female - Swivel 90° Elbow - Short
D						
	 DIN "S" Series	1D278 B-125  Male - Rigid	 DIN "S" Series w/O-Ring	1C978 B-125  Female - Rigid	10C78 B-125  Female - Swivel 45° Elbow	11C78 B-125  Female - Swivel 90° Elbow
E						
	 BSP 60° Cone	1GU78 B-125  Female - Swivel				

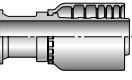
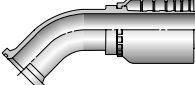
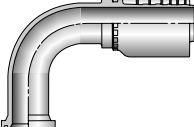
 <p><b>NPTF Pipe</b></p>	<p>101S6 B-126</p>  <p><i>Male - Rigid</i></p>	 <p><b>JIC 37°</b></p>	<p>106S6 B-126</p>  <p><i>Female - Swivel</i></p>	 <p><b>Code 61 Flange</b></p>	<p>14AS6 B-126</p>  <p><i>Flange (5000 psi)</i></p>
<p>14FS6 B-126</p>  <p><i>45° Elbow (5000 psi)</i></p>	<p>14NS6 B-126</p>  <p><i>90° Elbow (5000 psi)</i></p>	 <p><b>Code 62 Flange</b></p>	<p>16AS6 B-127</p>  <p><i>Flange Head - Straight</i></p>	<p>16FS6 B-127</p>  <p><i>45° Elbow</i></p>	<p>16NS6 B-127</p>  <p><i>90° Elbow</i></p>
 <p><b>Caterpillar® Flange</b></p>	<p>1XAS6 B-127</p>  <p><i>Flange</i></p>	 <p><b>Seal-Lok® (O-Ring Face Seal)</b></p>	<p>1JSS6 B-127</p>  <p><i>Female - Swivel</i></p>		

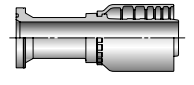
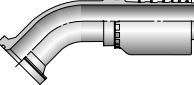
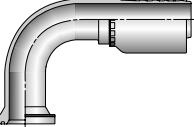
A

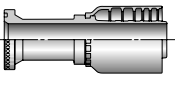
B

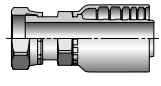
C

D

E

## 10178

### Male NPTF Pipe - Rigid

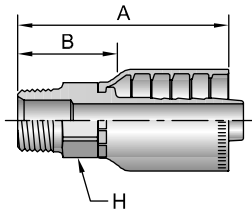

# Part Number	Thread inch	Hose I.D. inch	A		H		B	
			inch	mm	inch	inch	inch	mm
10178-12-12	3/4x14	3/4	3.56	90	1-1/8	1.80	46	
10178-16-16	1x11-1/2	1	3.94	100	1-3/8	2.09	53	
10178-20-20	1-1/4x11-1/2	1-1/4	4.92	125	1-3/4	2.53	64	
10178-24-24	1-1/2x11-1/2	1-1/2	4.88	124	2	2.67	68	

All sizes of 10178 fittings are rated at 5,000 psi working pressure.

## 10678

### Female JIC 37° - Swivel

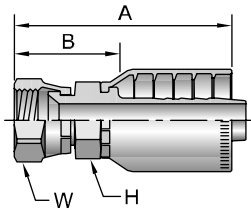

# Part Number	Thread inch	Hose I.D. inch	A		H	W	B		Additional Material Stainless Steel (C)	
			inch	mm	inch	inch	inch	mm		
10678-12-12	3/4	1-1/16x12	3/4	3.66	93	1-1/8	1-1/4	1.90	48	•
10678-16-12	1	1-5/16x12	3/4	3.90	99	1-3/8	1-1/2	2.14	54	•
10678-16-16	1	1-5/16x12	1	4.03	102	1-3/8	1-1/2	2.18	55	•
10678-20-20	1-1/4	1-5/8x12	1-1/4	4.93	125	1-3/4	2	2.54	65	•
10678-24-24	1-1/2	1-7/8x12	1-1/2	5.04	128	2	2-1/4	2.83	72	•

All sizes of 10678 fittings are rated at 5,000 psi working pressure.

⚠ Refer to Pressure Rating of Hose End Connections chart on page E-45.

## 13978

### Female JIC 37° - Swivel - 90° Elbow - Short Drop

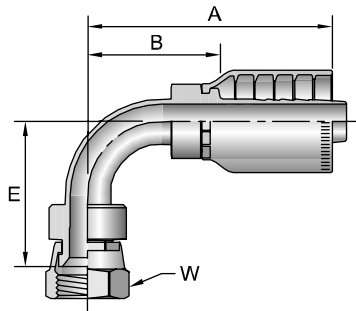

# Part Number	Thread inch	Hose I.D. inch	A		E		W	B		
			inch	mm	inch	mm	inch	inch	mm	
13978-12-12	3/4	1-1/16x12	3/4	4.12	105	2.44	62	1-1/2	2.36	60
13978-16-16	1	1-5/16x12	1	4.71	120	2.93	74	1-1/2	2.86	73
13978-20-20	1-1/4	1-5/8x12	1-1/4	5.67	144	3.35	85	2	3.28	83

All sizes of 13978 fittings are rated at 5,000 psi working pressure.

## 11578

### SAE Code 61 Flange Head ISO 12151-3 - S - L

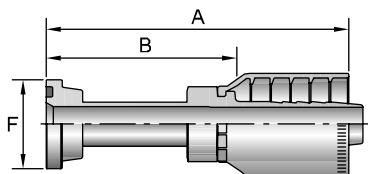

# Part Number	Flange inch	Hose I.D. inch	A		F	B	
			inch	mm	inch	inch	mm
11578-12-12	3/4	3/4	4.34	110	1-1/2	2.58	66
11578-16-16	1	1	4.59	117	1-3/4	2.74	70

See Accessories Section for O-Rings and Flange Kits.

## 14A78

SAE Code 61 Flange Head - 5,000 psi

ISO 12151-3 - S - L (5000 psi)

# Part Number	Flange inch	Hose I.D. inch	A		F inch	B	
			inch	mm		inch	mm
14A78-20-20	1-1/4	1-1/4	5.54	141	2	3.15	80
14A78-24-24	1-1/2	1-1/2	6.53	166	2-3/8	4.32	110
14A78-32-24	2	1-1/2	4.68	119	2-13/16	2.47	63

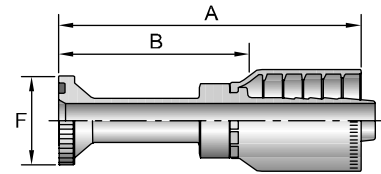

## 11778

SAE Code 61 Flange Head - 45° Elbow

ISO 12151-3 - E45S - L (1 Piece: ISO 12151-3 - E45M - L)

# Part Number	Flange inch	Hose I.D. inch	A		E		F inch	B	
			inch	mm	inch	mm		inch	mm
11778-12-12	3/4	3/4	4.67	119	1.06	27	1-1/2	2.91	74
11778-16-16	1	1	5.01	127	1.26	32	1-3/4	3.16	80

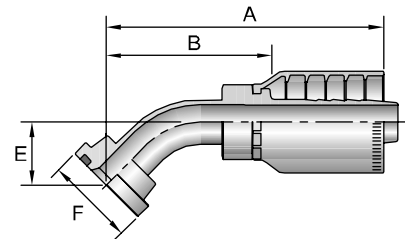

## 14F78

SAE Code 61 Flange Head - 45° Elbow - 5,000 psi

ISO 12151-3 - E45S - L (1 Piece: ISO 12151-3 - E45M - L) (5000 psi)

# Part Number	Flange inch	Hose I.D. inch	A		E		F inch	B	
			inch	mm	inch	mm		inch	mm
14F78-20-20	1-1/4	1-1/4	6.39	162	1.50	38	2	4.00	102
14F78-24-24	1-1/2	1-1/2	6.99	178	1.73	44	2-3/8	4.78	121

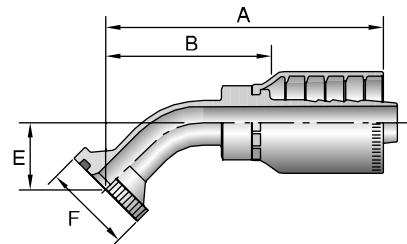

## 11978

SAE Code 61 Flange Head - 90° Elbow

ISO 12151-3 - E90S - L (1 Piece: ISO 12151-3 - E90M - L)

# Part Number	Flange inch	Hose I.D. inch	A		E		F inch	B	
			inch	mm	inch	mm		inch	mm
11978-12-12	3/4	3/4	4.35	110	2.25	57	1-1/2	2.59	66
11978-16-16	1	1	4.67	119	2.76	70	1-3/4	2.82	72

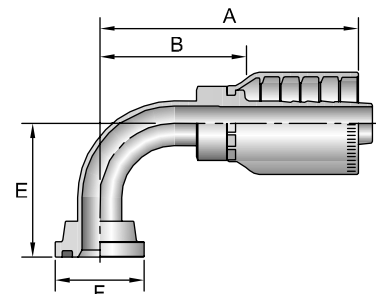





See Accessories Section for O-Rings and Flange Kits.

## 14N78

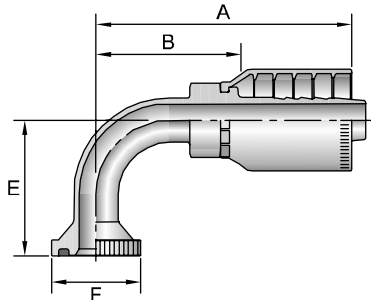
SAE Code 61 Flange Head - 90° Elbow - 5,000 psi

ISO 12151-3 - E90S - L (1 Piece: ISO 12151-3 - E90M - L) (5000 psi)







#			A		E			B	
Part Number	inch	inch	inch	mm	inch	mm	inch	inch	mm
14N78-20-16	1-1/4	1	4.63	118	2.76	70	2	2.78	71
14N78-20-20	1-1/4	1-1/4	6.09	155	3.54	90	2	3.70	94
14N78-24-24	1-1/2	1-1/2	6.52	166	4.09	104	2-3/8	4.31	109

## 16A78

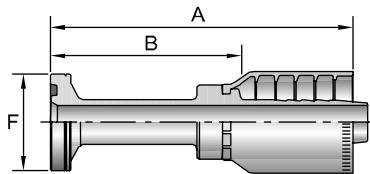
SAE Code 62 Flange Head

ISO 12151-3 - S - S







#			A			B	
Part Number	inch	inch	inch	mm	inch	inch	mm
16A78-12-12	3/4	3/4	4.60	117	1-5/8	2.84	72
16A78-16-12	1	3/4	3.57	91	1-7/8	1.81	46
16A78-16-16	1	1	5.16	131	1-7/8	3.31	84
16A78-20-16	1-1/4	1	3.95	100	2-1/8	2.10	53
16A78-20-20	1-1/4	1-1/4	5.85	149	2-1/8	3.46	88
16A78-24-20	1-1/2	1-1/4	4.77	121	2-1/2	2.38	60
16A78-24-24	1-1/2	1-1/2	6.54	166	2-1/2	4.33	110
16A78-32-24	2	1-1/2	5.07	129	3-1/8	2.86	73

## 16B78

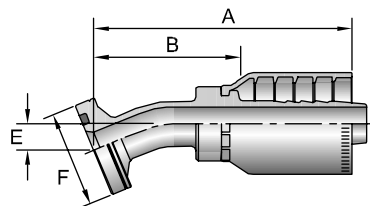
SAE Code 62 Flange Head - 22-1/2° Elbow

ISO 12151-3 - E22M - S







#			A		E			B	
Part Number	inch	inch	inch	mm	inch	mm	inch	inch	mm
16B78-16-16	1	1	4.57	116	0.46	12	1-7/8	2.72	60

## 16E78

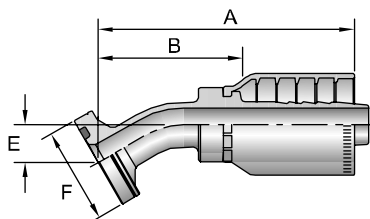
SAE Code 62 Flange Head - 30° Elbow

ISO 12151-3 - E30S - S (1 Piece: ISO 12151-3 - E30M - S)





#			A		E			B	
Part Number	inch	inch	inch	mm	inch	mm	inch	inch	mm
16E78-20-20	1-1/4	1-1/4	6.71	170	0.87	22	2-1/8	4.32	110
16E78-24-24	1-1/2	1-1/2	7.10	180	1.12	28	2-1/2	4.89	124

See Accessories Section for O-Rings and Flange Kits.

## 16F78

### SAE Code 62 Flange Head - 45° Elbow

ISO 12151-3 - E45S - S (1 Piece: ISO 12151-3 - E45M - S)

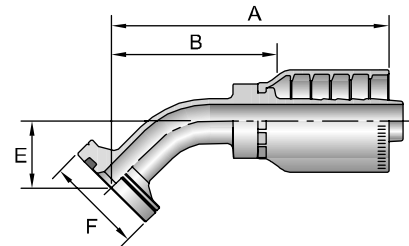

#			A		E			B	
			inch	mm	inch	mm		inch	mm
16F78-12-12	3/4	3/4	4.31	109	1.02	26	1-5/8	2.55	65
16F78-16-12	1	3/4	4.83	123	1.22	31	1-7/8	3.07	78
16F78-16-16	1	1	5.04	128	1.26	32	1-7/8	3.19	81
16F78-20-16	1-1/4	1	5.01	127	1.26	32	2-1/8	3.16	80
16F78-20-20	1-1/4	1-1/4	6.39	162	1.50	38	2-1/8	4.00	102
16F78-24-20	1-1/2	1-1/4	6.39	162	1.50	38	2-1/2	4.00	102
16F78-24-24	1-1/2	1-1/2	6.99	178	1.73	44	2-1/2	4.78	121



## 16G78

### SAE Code 62 Flange Head - 60° Elbow

ISO 12151-3 - E60S - S (1 Piece: ISO 12151-3 - E60M - S)

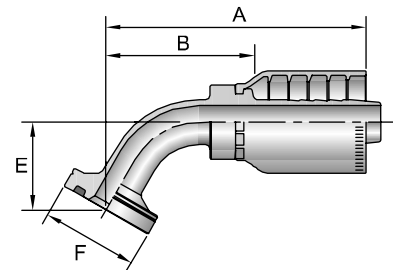

#			A		E			B	
			inch	mm	inch	mm		inch	mm
16G78-16-16	1	1	5.85	149	1.73	44	1-7/8	4.00	102
16G78-20-20	1-1/4	1-1/4	7.72	196	2.17	55	2-1/8	5.33	135
16G78-24-24	1-1/2	1-1/2	8.41	214	2.52	64	2-1/2	6.20	157



## 16N78

### SAE Code 62 Flange Head - 90° Elbow

ISO 12151-3 - E90S - S (1 Piece: ISO 12151-3 - E90M - S)

#			A		E			B	
			inch	mm	inch	mm		inch	mm
16N78-12-12	3/4	3/4	4.00	102	2.28	58	1-5/8	2.24	57
16N78-16-12	1	3/4	3.97	101	2.28	58	1-7/8	2.21	56
16N78-16-16	1	1	4.63	118	2.76	70	1-7/8	2.78	71
16N78-20-16	1-1/4	1	4.63	118	2.76	70	2-1/8	2.78	71
16N78-20-20	1-1/4	1-1/4	6.09	155	3.54	90	2-1/8	3.70	94
16N78-24-16	1-1/2	1	5.04	126	2.70	69	2-1/2	3.19	81
16N78-24-20	1-1/2	1-1/4	6.09	155	3.54	90	2-1/2	3.70	94
16N78-24-24	1-1/2	1-1/2	6.52	166	4.09	104	2-1/2	4.31	109
16N78-32-24	2	1-1/2	6.52	166	4.09	104	3-1/8	4.31	109

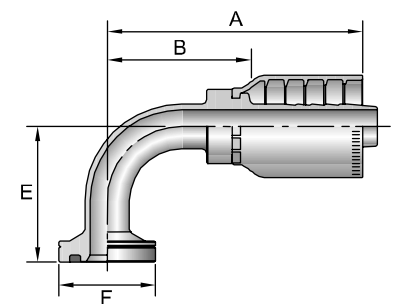

## 1XA78 Caterpillar® Flange Head

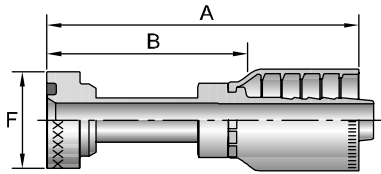

# Part Number	Flange inch	Hose I.D. inch	A		F inch	B	
			inch	mm		inch	mm
1XA78-12-12	3/4	3/4	4.85	123,2	1-5/8	3.09	78,5
1XA78-16-12	1	3/4	5.29	134,4	1-7/8	3.53	89,7
1XA78-16-16	1	1	5.44	138,2	1-7/8	3.59	91,2
1XA78-20-16	1-1/4	1	5.65	143,5	2-1/8	3.80	96,5
1XA78-20-20	1-1/4	1-1/4	6.10	154,9	2-1/8	3.71	94,2
1XA78-24-20	1-1/2	1-1/4	6.35	161,3	2-1/2	3.96	100,6
1XA78-24-24	1-1/2	1-1/2	6.78	172,2	2-1/2	4.57	116,1

## 1XB78 Caterpillar® Flange Head - 22-1/2° Elbow

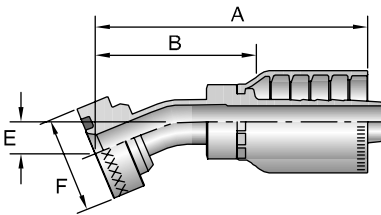

# Part Number	Flange inch	Hose I.D. inch	A		E		F inch	B	
			inch	mm	inch	mm		inch	mm
1XB78-12-12	3/4	3/4	4.59	117	0.54	14	1-5/8	2.83	72
1XB78-16-16	1	1	4.66	118	0.50	13	1-7/8	2.81	71
1XB78-20-16	1-1/4	1	4.66	118	0.50	13	2-1/8	2.81	71
1XB78-20-20	1-1/4	1-1/4	7.21	183	0.80	20	2-1/8	4.82	122
1XB78-24-20	1-1/2	1-1/4	7.21	183	0.80	20	2-1/2	4.82	122
1XB78-24-24	1-1/2	1-1/2	7.08	180	0.73	19	2-1/2	4.87	124

## 1XE78 Caterpillar® Flange Head - 30° Elbow

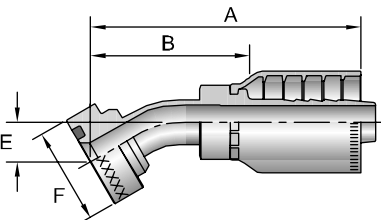

# Part Number	Flange inch	Hose I.D. inch	A		E		F inch	B	
			inch	mm	inch	mm		inch	mm
1XE78-16-16	1	1	5.08	129	0.79	20	1-7/8	3.23	82
1XE78-20-16	1-1/4	1	5.10	128	0.80	20	2-1/8	3.25	83
1XE78-20-20	1-1/4	1-1/4	6.38	162	0.93	24	2-1/8	3.99	101
1XE78-24-20	1-1/2	1-1/4	6.38	162	0.93	24	2-1/2	3.99	101
1XE78-24-24	1-1/2	1-1/2	7.10	180	1.14	29	2-1/2	4.89	124

Caterpillar® style fittings conform to the bolt hole patterns of SAE Code 62 and require special flange halves and seals. The Caterpillar® style flange heads are thicker than SAE Code 62 and measure to a .560" thickness in all sizes.

See Accessories Section for O-Rings and Flange Kits.

## 1XF78

### Caterpillar® Flange Head - 45° Elbow

# Part Number	Flange inch	Hose I.D. inch	A		E		F inch	B	
			inch	mm	inch	mm		inch	mm
1XF78-12-12	3/4	3/4	4.82	122	1.21	31	1-5/8	3.06	78
1XF78-16-12	1	3/4	4.81	120	1.20	30	1-7/8	3.05	77
1XF78-16-16	1	1	5.46	139	1.43	36	1-7/8	3.61	92
1XF78-20-16	1-1/4	1	5.46	139	1.43	36	2-1/8	3.61	92
1XF78-20-20	1-1/4	1-1/4	6.38	162	1.44	37	2-1/8	3.99	101
1XF78-24-20	1-1/2	1-1/4	6.38	162	1.44	37	2-1/2	3.99	101
1XF78-24-24	1-1/2	1-1/2	6.89	175	1.54	39	2-1/2	4.68	119

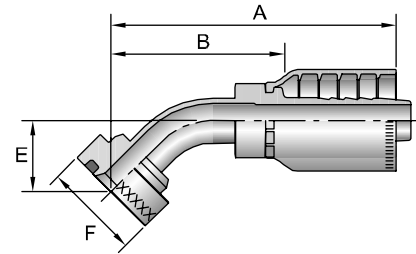

## 1XG78

### Caterpillar® Flange Head - 60° Elbow

# Part Number	Flange inch	Hose I.D. inch	A		E		F inch	B	
			inch	mm	inch	mm		inch	mm
1XG78-16-16	1	1	5.13	130	1.96	50	1-7/8	3.28	83
1XG78-20-20	1-1/4	1-1/4	6.72	171	2.02	51	2-1/8	4.33	110
1XG78-24-24	1-1/2	1-1/2	6.87	174	2.04	52	2-1/2	4.67	119

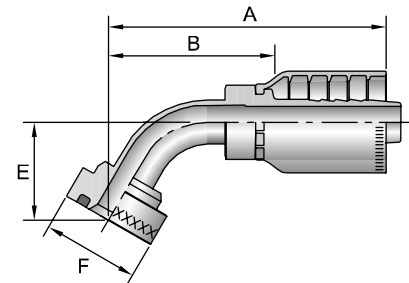

## 1XN78

### Caterpillar® Flange Head - 90° Elbow

# Part Number	Flange inch	Hose I.D. inch	A		E		F inch	B	
			inch	mm	inch	mm		inch	mm
1XN78-12-12	3/4	3/4	4.35	110	2.46	62	1-5/8	2.59	66
1XN78-12-16	3/4	1	4.58	116	2.46	62	1-5/8	2.73	69
1XN78-16-12	1	3/4	4.35	110	2.44	62	1-7/8	2.59	66
1XN78-16-16	1	1	5.04	128	2.90	74	1-7/8	3.19	81
1XN78-20-16	1-1/4	1	5.04	128	2.90	74	2-1/8	3.19	81
1XN78-20-20	1-1/4	1-1/4	6.75	171	3.02	77	2-1/8	4.36	111
1XN78-24-20	1-1/2	1-1/4	6.75	171	3.02	77	2-1/2	4.36	111
1XN78-24-24	1-1/2	1-1/2	5.85	149	3.41	87	2-1/2	3.64	92

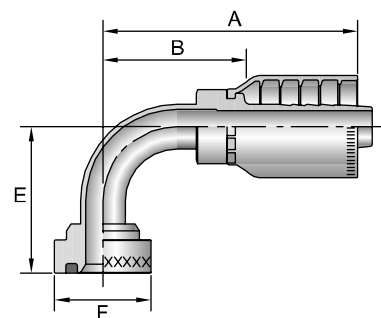

Caterpillar® style fittings conform to the bolt hole patterns of SAE Code 62 and require special flange halves and seals. The Caterpillar® style flange heads are thicker than SAE Code 62 and measure to a .560" thickness in all sizes.

See Accessories Section for O-Rings and Flange Kits.



## 1JS78

### Female Seal-Lok® - Swivel - Long

ISO 12151-1 - SWSB

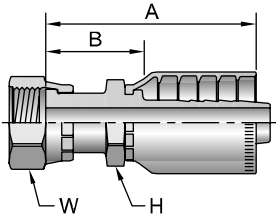

# Part Number	Thread		Hose I.D. inch	A		H inch	W inch	B	
	inch	inch		inch	mm			inch	mm
1JS78-12-12	3/4	1-3/16x12	3/4	3.70	94	1-1/8	1-3/8	1.94	49
1JS78-16-16	1	1-7/16x12	1	4.03	102	1-3/8	1-5/8	2.18	55
1JS78-20-16	1-1/4	1-11/16x12	1	3.99	101	1-3/4	1-7/8	2.14	54
1JS78-20-20	1-1/4	1-11/16x12	1-1/4	4.62	117	1-3/4	1-7/8	2.23	57
1JS78-24-24	1-1/2	2x12	1-1/2	4.70	119,4	2	2-1/4	2.49	63,2

⚠ Refer to Pressure Rating of Hose End Connections chart on page E-45.

## 1J778

### Female Seal-Lok® - Swivel - 45° Elbow

ISO 12151-1 - SWE45

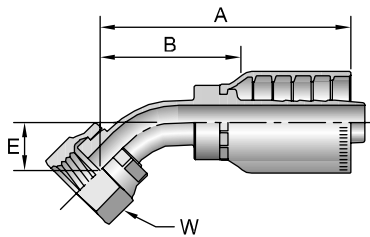

# Part Number	Thread		Hose I.D. inch	A		E		W inch	B	
	inch	inch		inch	mm	inch	mm		inch	mm
1J778-12-12	3/4	1-3/16x12	3/4	4.11	104	0.81	21	1-3/8	2.35	60
1J778-16-16	1	1-7/16x12	1	4.69	119	0.94	24	1-5/8	2.84	72
1J778-20-20	1-1/4	1-11/16x12	1-1/4	5.78	147	0.98	25	1-7/8	3.29	84
1J778-24-24	1-1/2	2x12	1-1/2	6.91	176	1.56	40	2-1/4	4.70	119

⚠ Refer to Pressure Rating of Hose End Connections chart on page E-45.

## 1J978

### Female Seal-Lok® - Swivel - 90° Elbow - Short Drop

ISO 12151-1 - SWES90

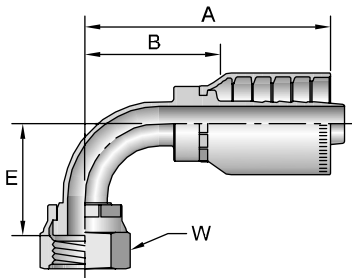

# Part Number	Thread		Hose I.D. inch	A		E		W inch	B	
	inch	inch		inch	mm	inch	mm		inch	mm
1J978-12-12	3/4	1-3/16x12	3/4	3.97	100	1.89	48	1-3/8	2.21	56
1J978-16-16	1	1-7/16x12	1	4.62	117	2.21	56	1-5/8	2.77	70
1J978-20-20	1-1/4	1-11/16x12	1-1/4	5.82	148	2.52	64	1-7/8	3.43	87
1J978-24-24	1-1/2	2x12	1-1/2	6.58	167	2.70	69	2-1/4	4.37	111

⚠ Refer to Pressure Rating of Hose End Connections chart on page E-45.

See Accessories Section for O-Rings and Flange Kits.

## 1D278

Male Metric S - Rigid - (24° Cone)

# Part Number	Thread		Hose I.D. inch	A		H mm	B	
	mm	M		inch	mm		inch	mm
1D278-25-12	25	M36x2	3/4	3.38	86	36	1.62	41
1D278-30-16	30	M42x2	1	3.72	94	46	1.87	47
1D278-38-20	38	M52x2	1-1/4	4.42	112	55	2.03	52

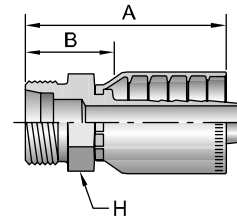

## 1C978

Female Metric S - Swivel - (24° Cone with O-Ring)

# Part Number	Thread		Hose I.D. inch	A		C		W mm	B	
	mm	M		inch	mm	inch	mm		inch	mm
1C978-25-12	25	M36x2	3/4	3.12	79	0.10	3	46	1.36	35
1C978-30-16	30	M42x2	1	3.40	86	0.19	5	50	1.55	39
1C978-38-20	38	M52x2	1-1/4	3.98	101	0.23	6	60	1.59	40

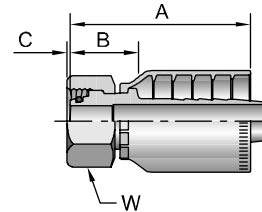

When measuring overall length to the end of the nut, B+C dimensions must be used to calculate cut-off allowance.

## 10C78

Female Metric S - Swivel - 45° Elbow - (24° Cone with O-Ring)  
 ISO 12151-2 - SWE45 - S

# Part Number	Thread		Hose I.D. inch	A		E		W mm	B	
	mm	M		inch	mm	inch	mm		inch	mm
10C78-25-12	25	M36x2	3/4	4.45	113	1.14	29	46	2.56	65
10C78-30-16	30	M42x2	1	5.16	131	1.34	34	50	3.19	81
10C78-38-20	38	M52x2	1-1/4	6.44	164	1.50	38	60	4.05	103

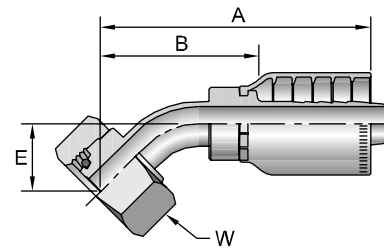

## 11C78

Female Metric S - Swivel - 90° Elbow - (24° Cone with O-Ring)  
 ISO 12151-2 - SWE - S

# Part Number	Thread		Hose I.D. inch	A		E		W mm	B	
	mm	M		inch	mm	inch	mm		inch	mm
11C78-25-12	25	M36x2	3/4	4.12	105	2.32	59	46	2.36	60
11C78-30-16	30	M42x2	1	4.71	120	2.68	68	50	2.86	73
11C78-38-20	38	M52x2	1-1/4	5.67	144	2.86	73	60	3.28	83

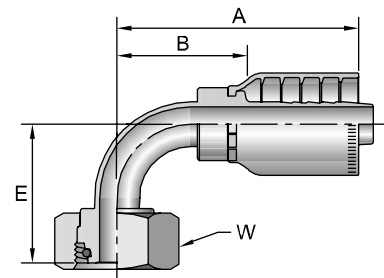

## 1GU78

Female BSP Parallel Pipe - Swivel - (60° Cone)

# Part Number	Thread		Hose I.D. inch	A		H mm	W mm	B	
	inch	BSP		inch	mm			inch	mm
1GU78-12-12	3/4x14		3/4	3.76	96	36	36	2.00	51
1GU78-16-16	1x11		1	4.14	105	41	41	2.29	58

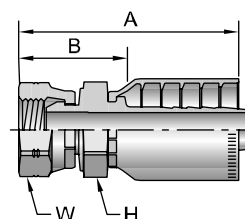

Metric S: Mates with EO "S" Series Fittings. See Accessories Section for O-Rings and Flange Kits.