

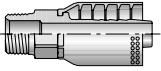









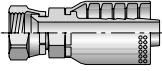
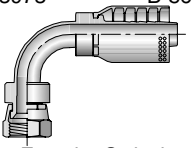

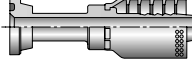
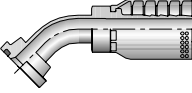
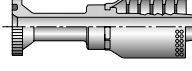
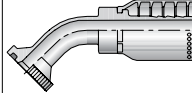
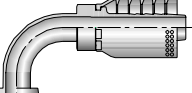
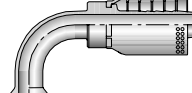

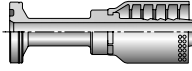
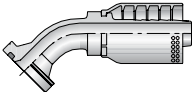
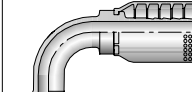
 NPTF Pipe	10173 B-86  <i>Male - Rigid</i>	 JIC 37°	10673 B-86  <i>Female - Swivel</i>	13973 B-86  <i>Female - Swivel 90° Elbow - Short</i>	 Code 61 Flange
11573 B-86  <i>Flange</i>	11773 B-87  <i>45° Elbow</i>	14A73 B-87  <i>Flange (5000 psi)</i>	14F73 B-87  <i>45° Elbow (5000 psi)</i>	11973 B-87  <i>90° Elbow</i>	14N73 B-88  <i>90° Elbow (5000 psi)</i>
 Code 62 Flange	16A73 B-88  <i>Flange</i>	16F73 B-88  <i>45° Elbow</i>	16N73 B-88  <i>90° Elbow</i>	 Seal-Lok® (O-Ring Face Seal)	1JS73 B-89  <i>Female - Swivel Long</i>
1J773 B-89  <i>Female - Swivel 45° Elbow</i>	1J973 B-89  <i>Female - Swivel 90° Elbow - Short</i>	 BSP 60° Cone	1GU73 B-90  <i>Female - Swivel</i>	1G173 B-90  <i>Female - Swivel 45° Elbow</i>	1G273 B-90  <i>Female - Swivel 90° Elbow</i>
 DIN "L" Series	1CA73 B-91  <i>Female Metric L - Swivel</i>	 DIN "S" Series	1D273 B-91  <i>Male Metric S - Rigid</i>	1C973 B-91  <i>Female Metric S - Swivel</i>	10C73 B-91  <i>Female Metric S - Swivel</i>
11C73 B-92  <i>Female Metric S - Swivel</i>	 BSP 60° Cone	1D973 B-92  <i>Male BSP - Parallel Pipe - Rigid</i>	19273 B-92  <i>Female BSP - Parallel Pipe - Swivel</i>	1B173 B-93  <i>Female BSP - Parallel Pipe - Swivel</i>	1B273 B-93  <i>Female BSP - Parallel Pipe - Swivel</i>

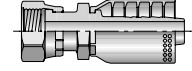
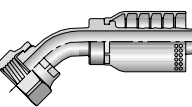
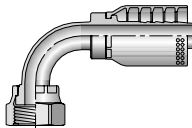
A

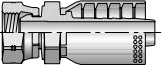
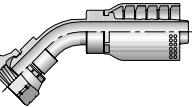
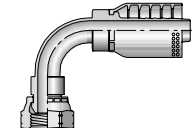
B

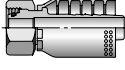
C

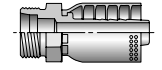
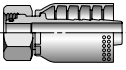
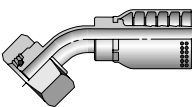
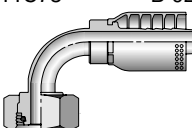
D

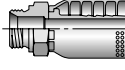
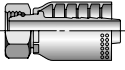
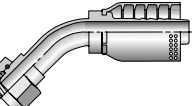
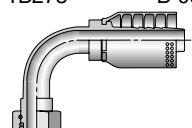
E

A

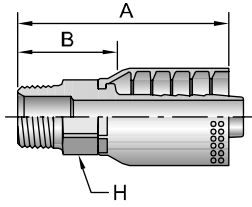

10173

Male NPTF Pipe - Rigid

# Part Number	Thread inch	Hose I.D. inch	A		H inch	B	
			inch	mm		inch	mm
10173-12-12	3/4x14	3/4	3.56	90	1-1/8	1.75	44
10173-16-16	1x11-1/2	1	3.94	100	1-3/8	2.00	51
10173-20-20	1-1/4x11-1/2	1-1/4	4.92	125	1-3/4	2.43	62
10173-24-24	1-1/2x11-1/2	1-1/2	4.88	124	2	2.57	65
10173-32-32	2x11-1/2	2	5.57	141	2-1/2	2.87	73

Note: All sizes of 10173 fittings are rated at 5,000 psi working pressure.

B

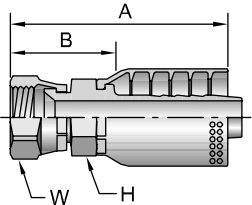

10673

Female JIC 37° - Swivel

# Part Number	Thread inch		Hose I.D. inch	A		H inch	W inch	B	
	inch	mm		inch	mm			inch	mm
10673-12-12	3/4	1-1/16x12	3/4	3.66	93	1-1/8	1-1/4	1.85	47
10673-16-12	1	1-5/16x12	3/4	3.90	99	1-3/8	1-1/2	2.09	53
10673-16-16	1	1-5/16x12	1	4.03	102	1-3/8	1-1/2	2.09	53
10673-20-20	1-1/4	1-5/8x12	1-1/4	4.93	125	1-3/4	2	2.44	62
10673-24-24	1-1/2	1-7/8x12	1-1/2	5.04	128	2	2-1/4	2.73	69
10673-32-32	2	2-1/2x12	2	5.91	150	2-1/2	2-7/8	3.21	82

Note: All sizes of 10673 fittings are rated at 5,000 psi working pressure.

C

13973

Female JIC 37° - Swivel - 90° Elbow - Short Drop

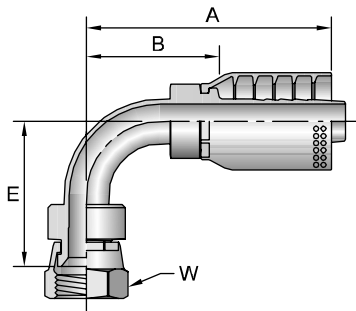

# Part Number	Thread inch		Hose I.D. inch	A		E		W inch	B	
	inch	mm		inch	mm	inch	mm		inch	mm
13973-12-12	3/4	1-1/16x12	3/4	4.12	105	2.44	62	1-1/4	2.31	59
13973-16-16	1	1-5/16x12	1	4.71	120	2.93	74	1-1/2	2.77	70

Note: All sizes of 13973 fittings are rated at 5,000 psi working pressure.

D

11573

SAE Code 61 Flange Head ISO 12151-3 - S - L

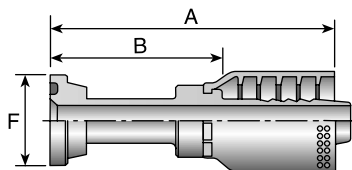

# Part Number	Flange inch	Hose I.D. inch	A		F inch	B	
			inch	mm		inch	mm
11573-12-12	3/4	3/4	4.34	110,2	1-1/2	2.53	64,3
11573-16-16	1	1	4.59	117	1-3/4	2.65	67

See Accessories Section for O-Rings and Flange Kits.

11773

SAE Code 61 Flange Head - 45° Elbow

ISO 12151-3 - E450S - L (1 Piece: ISO 12151-3 - E45M - L)

# Part Number	Flange inch	Hose I.D. inch	A		E		F inch	B	
			inch	mm	inch	mm		inch	mm
11773-12-12	3/4	3/4	4.31	109	1.02	26	1-1/2	2.50	64
11773-16-16	1	1	5.01	127	1.26	32	1-3/4	3.07	78

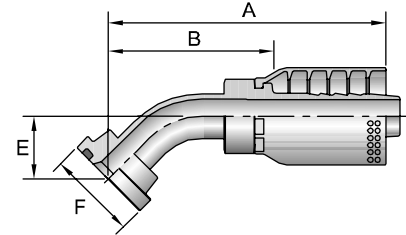

14A73

SAE Code 61 Flange Head - 5000 psi

ISO 12151-3 - S - L

# Part Number	Flange inch	Hose I.D. inch	A		F inch	B	
			inch	mm		inch	mm
14A73-20-20	1-1/4	1-1/4	5.54	141	2	3.05	77
14A73-24-24	1-1/2	1-1/2	6.53	166	2-3/8	4.22	107
14A73-32-32	2	2	6.14	156	2-13/16	3.44	87

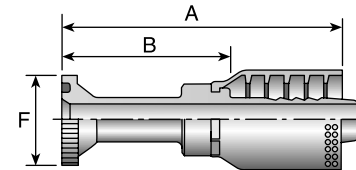

14F73

SAE Code 61 Flange Head - 45° Elbow - 5000 psi

ISO 12151-3 - E45S - L (1 Piece: ISO 12151-3 - E45M - L)

# Part Number	Flange inch	Hose I.D. inch	A		E		F inch	B	
			inch	mm	inch	mm		inch	mm
14F73-20-20	1-1/4	1-1/4	6.39	162	150	38	2	3.90	99
14F73-24-24	1-1/2	1-1/2	6.99	178	1.73	44	2-3/8	4.68	119
14F73-32-32	2	2	8.40	214	2.21	56	2-13/16	5.71	145

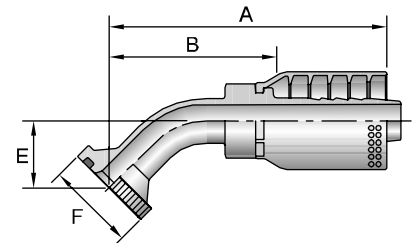

11973

SAE Code 61 Flange Head - 90° Elbow

ISO 12151-3 - E90S - L (1 Piece: ISO 12151-3 - E90M - L)

# Part Number	Flange inch	Hose I.D. inch	A		E		F inch	B	
			inch	mm	inch	mm		inch	mm
11973-12-12	3/4	3/4	3.97	101	2.28	58	1-1/2	2.16	55
11973-16-12	1	3/4	4.00	102	2.28	58	1-3/4	2.19	56
11973-16-16	1	1	4.63	118	2.76	70	1-3/4	2.69	68

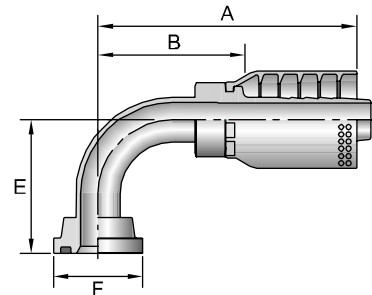

A

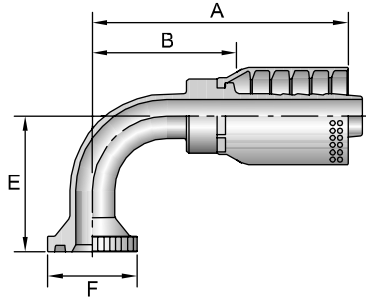

14N73

SAE Code 61 Flange Head - 90° Elbow - 5000 psi

ISO 12151-3 - E90S - L (1 Piece: ISO 12151-3 - E90M - L)

# Part Number	Flange inch	Hose I.D. inch	A		E		F inch	B	
			inch	mm	inch	mm		inch	mm
14N73-20-20	1-1/4	1-1/4	6.09	155	3.54	90	2	3.60	91
14N73-24-24	1-1/2	1-1/2	6.52	166	4.09	104	2-3/8	4.21	107
14N73-32-32	2	2	7.82	199	5.43	138	2-13/16	5.12	130

B

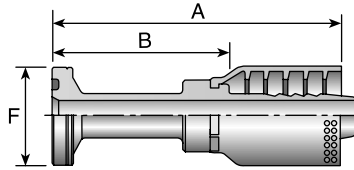

16A73

SAE Code 62 Flange Head

ISO 12151-3 - S - S

# Part Number	Flange inch	Hose I.D. inch	A		F inch	B	
			inch	mm		inch	mm
16A73-12-12	3/4	3/4	4.60	117	1-5/8	2.79	71
16A73-16-16	1	1	5.16	131	1-7/8	3.22	82
16A73-20-16	1-1/4	1	3.95	100	2-1/8	2.01	51
16A73-20-20	1-1/4	1-1/4	5.85	149	2-1/8	3.36	85
16A73-24-24	1-1/2	1-1/2	6.54	166	2-1/2	4.23	107
16A73-32-32	2	2	7.63	194	3-1/8	4.93	125

C

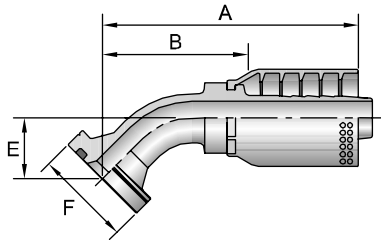

16F73

SAE Code 62 Flange Head - 45° Elbow

ISO 12151-3 - E45S - S (1 Piece: ISO 12151-3 - E45M - S)

# Part Number	Flange inch	Hose I.D. inch	A		E		F inch	B	
			inch	mm	inch	mm		inch	mm
16F73-12-12	3/4	3/4	4.31	109	1.02	26	1-5/8	2.50	64
16F73-16-16	1	1	5.01	127	1.26	32	1-7/8	3.07	78
16F73-20-20	1-1/4	1-1/4	6.39	162	1.50	38	2-1/8	3.90	99

D

E

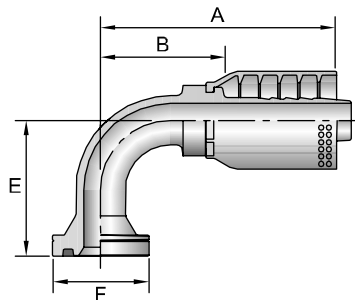

16N73

SAE Code 62 Flange Head - 90° Elbow

ISO 12151-3 - E90S - S (1 Piece: ISO 12151-3 - E90M - S)

# Part Number	Flange inch	Hose I.D. inch	A		E		F inch	B	
			inch	mm	inch	mm		inch	mm
16N73-12-12	3/4	3/4	3.97	101	2.28	58	1-5/8	2.16	55
16N73-16-16	1	1	4.63	118	2.76	70	1-7/8	2.69	68
16N73-20-20	1-1/4	1-1/4	6.09	151	3.54	90	2-1/8	3.60	91
16N73-24-24	1-1/2	1-1/2	6.52	166	4.09	104	2-1/2	4.21	107
16N73-32-32	2	2	7.82	199	5.43	138	3-1/8	5.12	130

1JS73

Female Seal-Lok® - Swivel - Long

ISO 12151-1 - SWSB

# Part Number	Thread		Hose I.D. inch	A		H inch	W inch	B	
	inch	1-3/16x12		inch	mm			inch	mm
1JS73-12-12	3/4	1-3/16x12	3/4	3.70	94	1-1/8	1-3/8	1.89	48
1JS73-16-12	1	1-7/16x12	3/4	3.78	96	1-3/8	1-5/8	1.97	50
1JS73-16-16	1	1-7/16x12	1	4.03	102	1-3/8	1-5/8	2.09	53
1JS73-20-20	1-1/4	1-11/16x12	1-1/4	4.62	132	1-3/4	1-7/8	2.13	69

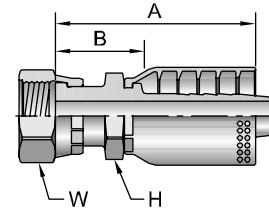

1J773

Female Seal-Lok® - Swivel - 45° Elbow

ISO 12151-1 - SWE45

# Part Number	Thread		Hose I.D. inch	A		E		W inch	B	
	inch	1-3/16x12		inch	mm	inch	mm		inch	mm
1J773-12-12	3/4	1-3/16x12	3/4	4.11	104	0.81	21	1-3/8	2.30	58
1J773-16-16	1	1-7/16x12	1	4.69	119	0.94	24	1-5/8	2.75	70
1J773-20-20	1-1/4	1-11/16x12	1-1/4	5.78	147	0.98	25	1-7/8	3.29	84

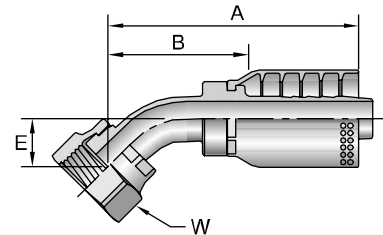

1J973

Female Seal-Lok® - Swivel - 90° Elbow - Short Drop

ISO 12151-1 - SWES90

# Part Number	Thread		Hose I.D. inch	A		E		W inch	B	
	inch	1-3/16x12		inch	mm	inch	mm		inch	mm
1J973-12-12	3/4	1-3/16x12	3/4	3.97	100	1.89	48	1-3/8	2.16	55
1J973-16-16	1	1-7/16x12	1	4.62	117	2.20	56	1-5/8	2.68	68
1J973-20-20	1-1/4	1-11/16x12	1-1/4	5.82	148	2.52	64	1-7/8	3.33	85

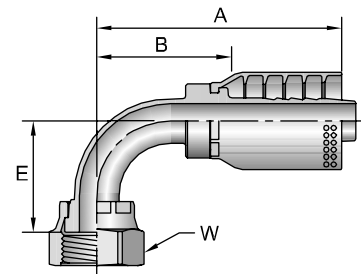

A

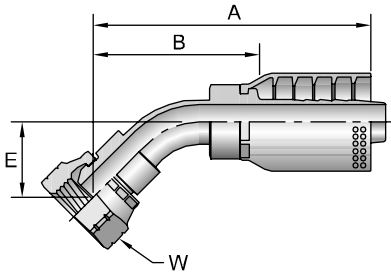

1G173

Female BSP Parallel Pipe - Swivel - 45° Elbow - (60° Cone)

# Part Number	Thread inch	Hose I.D. inch	A		E		W mm	B	
			inch	mm	inch	mm		inch	mm
1G173-12-12	3/4x14	3/4	4.77	121,2	1.35	34,4	36	2.96	75,2
1G173-16-16	1x11	1	5.36	136,1	1.52	38,7	41	3.42	86,9

B

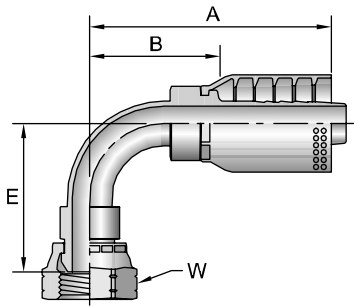

1G273

Female BSP Parallel Pipe - Swivel - 90° Elbow - (60° Cone)

# Part Number	Thread inch	Hose I.D. inch	A		E		W mm	B	
			inch	mm	inch	mm		inch	mm
1G273-12-12	3/4x14	3/4	4.12	104,6	2.62	66,6	36	2.31	58,7
1G273-16-16	1x11	1	4.71	119,6	3.04	77,2	41	2.77	70,4

C

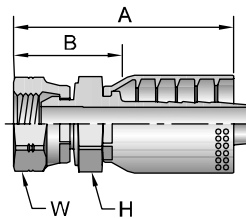

1GU73

Female BSP Parallel Pipe - Swivel - (60° Cone)

# Part Number	Thread inch	Hose I.D. inch	A		H	W	B	
			inch	mm	mm	mm	inch	mm
1GU73-12-12	3/4x14	3/4	3.76	95,5	36	36	1.95	49,5
1GU73-16-16	1x11	1	4.14	105	41	41	2.20	56

D

E

1CA73

Female Metric L - Swivel - (24° Cone with O-Ring)

ISO 12151-2 - SWS

# Part Number	Thread		Hose I.D. inch	A		C	W	B		
	mm	mm		inch	mm			inch	mm	mm
1CA73-28-16	25	M36x2	1	3.43	87	0.14	3.56	41	1.42	36

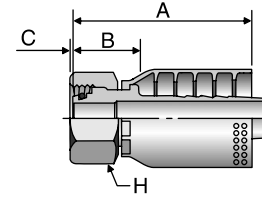

1D273

Male Metric S - Rigid - (24° Cone)

ISO 12151-2

# Part Number	Thread		Hose I.D. inch	A		H	B	
	mm	mm		inch	mm		inch	mm
1D273-20-12	20	M30x2	3/4	3.31	84	30	1.42	36
1D273-25-12	25	M36x2	3/4	3.39	86	36	1.50	38
1D273-30-16	30	M42x2	1	3.70	94	46	1.73	44
1D273-38-20	38	M52x2	1-1/4	4.41	112	55	1.89	48

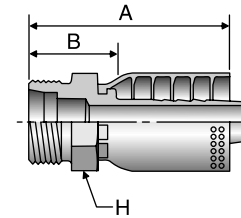

1C973

Female Metric S - Swivel - (24° Cone with O-Ring)

ISO 12151-2 - SWS

# Part Number	Thread		Hose I.D. inch	A		C	W	B		
	mm	mm		inch	mm			inch	mm	mm
1C973-20-12	20	M30x2	3/4	3.19	81	0.05	1.3	36	1.30	33
1C973-25-12	25	M36x2	3/4	3.15	80	0.09	2.3	46	1.26	32
1C973-25-16	25	M36x2	1	3.43	87	0.09	2.3	46	1.42	36
1C973-30-16	30	M42x2	1	3.43	87	0.19	4.8	50	1.42	36
1C973-30-20	30	M42x2	1-1/4	4.17	106	0.19	4.8	50	1.65	42
1C973-38-20	38	M52x2	1-1/4	4.02	102	0.23	5.8	60	1.38	35

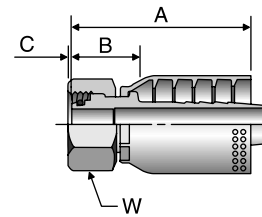

10C73

Female Metric S - Swivel - 45° Elbow - (24° Cone with O-Ring)

ISO 12151-2 - SWE45 - S

# Part Number	Thread		Hose I.D. inch	A		E	W	B		
	mm	mm		inch	mm			inch	mm	mm
10C73-20-12	20	M30x2	3/4	4.41	112	1.10	28	36	2.52	64
10C73-25-12	25	M36x2	3/4	4.45	113	1.14	29	46	2.56	65
10C73-30-16	30	M42x2	1	5.16	131	1.34	34	50	3.19	81

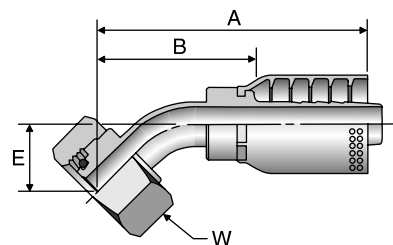

A

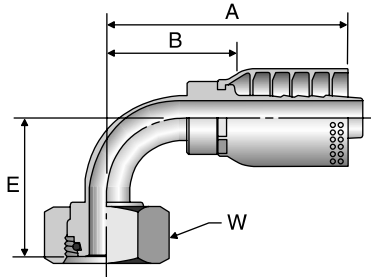

11C73

Female Metric S - Swivel - 90° Elbow - (24° Cone with O-Ring)
 ISO 12151-2 - SWE - S

# Part Number	Thread		Hose I.D. inch	A		E		W mm	B	
	mm			inch	mm	inch	mm		inch	mm
11C73-20-12	20	M30X2	3/4	3.98	101	2.24	57	36	2.09	53
11C73-25-12	25	M36X2	3/4	3.98	101	2.32	59	46	2.05	52
11C73-25-16	25	M36X2	1	4.80	122	2.76	70	46	2.80	71
11C73-30-16	30	M42X2	1	4.80	122	2.87	73	50	2.83	72
11C73-38-20	38	M52X2	1-1/4	5.94	151	3.07	78	60	3.43	87

B

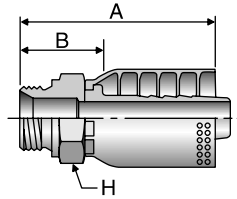

1D973

Male BSP Parallel Pipe - Rigid - (60° Cone)
 ISO 228-1

# Part Number	Thread		Hose I.D. inch	A		H mm	B	
	BSP			inch	mm		inch	mm
1D973-12-12	19,1	3/4x14	3/4	3.43	87	32	1.50	38
1D973-16-16	25,4	1x11	1	3.74	95	41	1.69	43

C

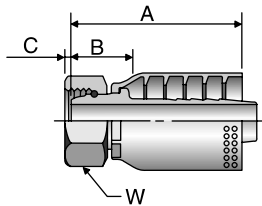

19273

Female BSP Parallel Pipe - Swivel - (60° Cone)
 ISO 228-1

# Part Number	Thread		Hose I.D. inch	A		C		W mm	B	
	inch			inch	mm	inch	mm		inch	mm
19273-12-12	3/4x14		3/4	3.03	77	0.46	11.7	32	1.14	29
19273-16-16	1x11		1	3.50	89	0.44	11.2	41	1.50	38
19273-20-20	1-1/4x11		1-1/4	3.98	101	0.52	13.2	50	1.46	37

D

E

1B173

Female BSP Parallel Pipe - Swivel- 45° Elbow - (60° Cone)

ISO 228-1

# Part Number	Thread inch	Hose I.D. inch	A		E		W mm	B	
			inch	mm	inch	mm		inch	mm
1B173-12-12	3/4x14	3/4	4.33	110	1.02	26	32	2.44	62
1B173-16-16	1x11	1	5.35	136	1.54	39	41	3.31	84

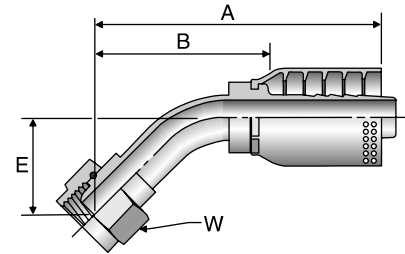

1B273

Female BSP Parallel Pipe - Swivel - 90° Elbow - (60° Cone)

ISO 228-1

# Part Number	Thread inch	Hose I.D. inch	A		E		W mm	B	
			inch	mm	inch	mm		inch	mm
1B273-12-12	3/4x14	3/4	4.17	106	2.17	55	32	2.28	58
1B273-16-16	1x11	1	4.76	121	2.99	76	41	2.76	70
1B273-20-20	1-1/4x11	1-1/4	5.94	151	3.15	80	50	3.43	87

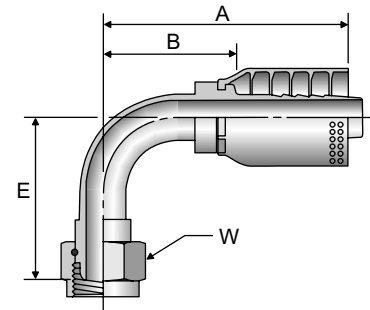

A

B

C

D

E