

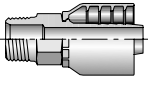







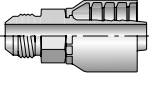
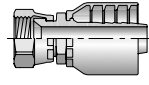
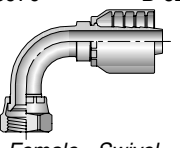

 NPTF Pipe	10170 B-62  <i>Male - Rigid</i>	 JIC 37°	10370 B-62  <i>Male - Rigid</i>	10670 B-62  <i>Female - Swivel</i>	13970 B-62  <i>Female - Swivel 90° Elbow - Short</i>
 Code 61 Flange	11770 B-63  <i>45° Elbow</i>	11970 B-63  <i>90° Elbow</i>	 Code 62 Flange	16A70 B-63  <i>Flange Head</i>	16N70 B-64  <i>90° Elbow</i>
 Seal-Lok® (O-Ring Face Seal)	1JC70 B-64  <i>Female - Swivel Short</i>	1JS70 B-64  <i>Female - Swivel Long</i>	1J770 B-64  <i>Femal - Swivel 45° Elbow</i>	1J970 B-65  <i>Female - Swivel 90° Elbow - Short</i>	1J570 B-65  <i>Female - Swivel 90° Elbow - Medium</i>
1J170 B-65  <i>Female - Swivel 90° Elbow - Long</i>	 BSP 60° Cone	1GU70 B-66  <i>Female - Swivel</i>	 French Gaz	1FG70 B-66  <i>Male - Rigid</i>	 Metric
10C70 B-67  <i>Female Metric S - Swivel - 45° Elbow</i>	11C70 B-67  <i>Female Metric S - Swivel - 90° Elbow</i>	19270 B-67  <i>Female BSP - Swivel - 60° Cone</i>	1B170 B-67  <i>Female BSP - Swivel - 45° Elbow</i>	1B270 B-68  <i>Female BSP - Swivel - 90° Elbow</i>	1C970 B-68  <i>Female - Swivel</i>
1CA70 B-68  <i>Female Metric L - Swivel - 24° Cone</i>	1CE70 B-68  <i>Female Metric L - Swivel - 45° Elbow</i>	1CF70 B-69  <i>Female Metric L - Swivel - 90° Elbow</i>	1D270 B-69  <i>Male Metric S - Rigid</i>	1D970 B-69  <i>Male - BSP - Rigid</i>	

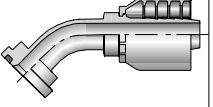
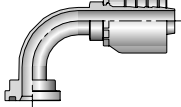
A

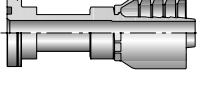
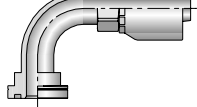
B

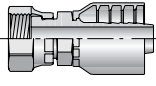
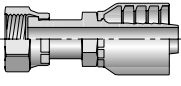
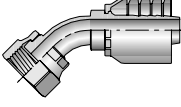
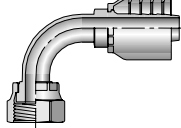
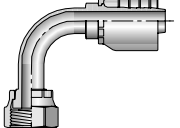
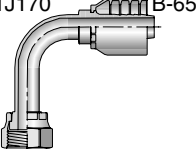
C

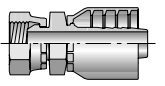
D

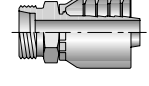
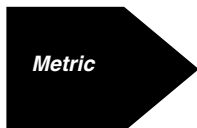
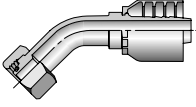
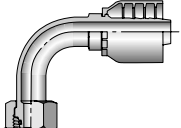
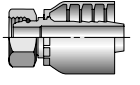
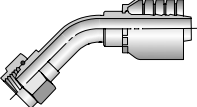
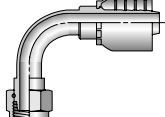
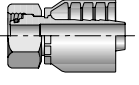
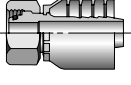
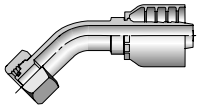
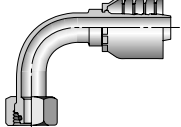
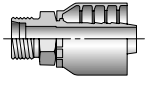
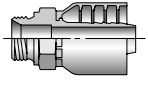
E

A

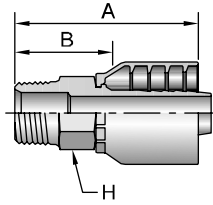

10170

Male NPTF Pipe - Rigid

# Part Number	Thread		Hose I.D.		A		H		B	
	inch	inch	inch	mm	inch	mm	inch	mm	inch	mm
10170-6-6	3/8x18		3/8	2.37	60		3/4		1.47	37
10170-8-8	1/2x14		1/2	2.84	72		7/8		1.40	36

B

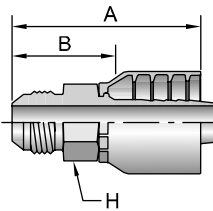

10370

Male JIC 37° - Rigid

# Part Number	Thread		Hose I.D.		A		H		B	
	inch	inch	inch	mm	inch	mm	inch	mm	inch	mm
10370-8-8	1/2	3/4x16	1/2	2.68	68		7/8		1.47	37
10370-10-8	5/8	7/8x14	1/2	2.62	66		15/16		1.41	36

C

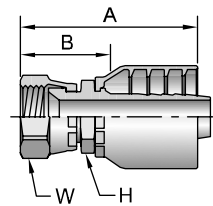

10670

Female JIC 37° - Swivel

# Part Number	Thread		Hose I.D.		A		H		W		B	
	inch	inch	inch	mm	inch	mm	inch	mm	inch	mm	inch	mm
10670-6-6	3/8	9/16x18	3/8	2.29	58		11/16		11/16		1.39	35
10670-8-8	1/2	3/4x16	1/2	2.62	67		13/16		7/8		1.41	36
10670-10-8	5/8	7/8x14	1/2	2.85	72		7/8		1		1.64	42
10670-10-10	5/8	7/8x14	5/8	2.84	72		15/16		1		1.59	40

D

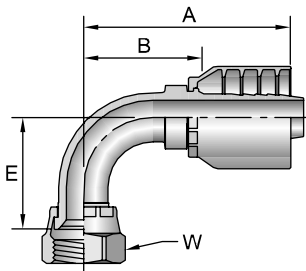

13970

Female JIC 37° - Swivel - 90° Elbow - Short Drop



# Part Number	Thread		Hose I.D.		A		E		W		B			
	inch	inch	inch	mm	inch	mm	inch	mm	inch	mm	inch	mm		
13970-8-8	1/2	3/4x16	1/2	2.62	67		1.14		29		7/8		1.41	36

E

11770

SAE Code 61 Flange Head - 45° Elbow

ISO 12151-3 - 45S - L

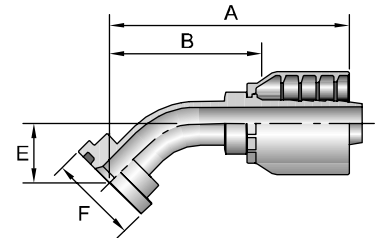

#			A		E			B	
Part Number	Flange inch	Hose I.D. inch	inch	mm	inch	mm	inch	inch	mm
11770-8-8	1/2	1/2	3.28	83	0.77	20	1-3/16	2.07	53
11770-12-10	3/4	5/8	3.37	86	0.76	19	1-1/2	2.12	54



11970

SAE Code 61 Flange Head - 90° Elbow

ISO 12151-3 - E90S - L

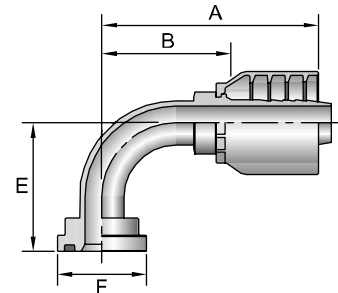

#			A		E			B	
Part Number	Flange inch	Hose I.D. inch	inch	mm	inch	mm	inch	inch	mm
11970-8-8	1/2	1/2	2.93	74	1.60	41	1-3/16	1.72	44
11970-12-10	3/4	5/8	3.54	90	2.02	51	1-1/2	2.29	58



16A70

SAE Code 62 Flange Head

ISO 12151-3 - S - S

#			A			B	
Part Number	Flange inch	Hose I.D. inch	inch	mm	inch	inch	mm
16A70-8-8	1/2	1/2	3.50	88,9	1-1/4	2.29	56,9

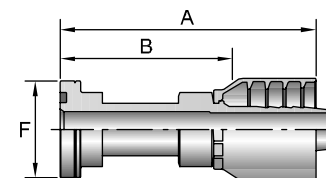

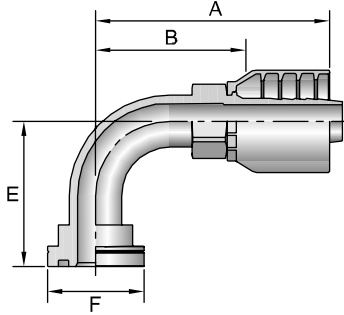

A



16N70

SAE Code 62 Flange Head - 90° Elbow

ISO 12151-3 - E90S - S (1 Piece: ISO 12151-3 - E90M - S)

#			A		E			B	
Part Number	Flange inch	Hose I.D. inch	inch	mm	inch	mm	inch	inch	mm
16N70-8-8	1/2	1/2	2.60	66	1.61	41	1-1/4	1.34	34



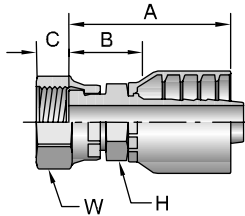

B



1JC70

Female Seal-Lok® - Swivel - Short

ISO 12151- 1 - SWSA

#			A		C				B	
Part Number	Thread inch	Hose I.D. inch	inch	mm	inch	mm	inch	inch	inch	mm
1JC70-6-6	3/8 11/16x16	3/8	1.94	49	0.34	9	11/16	13/16	1.04	26
1JC70-8-6	1/2 13/16x16	3/8	2.00	51	0.43	11	13/16	15/16	1.10	28
1JC70-8-8	1/2 13/16x16	1/2	2.22	56	0.43	11	13/16	15/16	1.01	26
1JC70-10-10	5/8 1x14	5/8	2.40	61	0.53	13	15/16	1-1/8	1.15	29



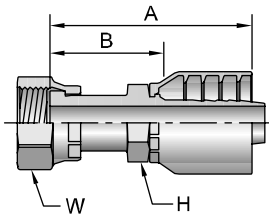

C



1JS70

Female Seal-Lok® - Swivel - Long

ISO 12151-1 - SWSB

#			A				B	
Part Number	Thread inch	Hose I.D. inch	inch	mm	inch	inch	inch	mm
1JS70-6-6	3/8 11/16x16	3/8	2.28	58	11/16	13/16	1.38	35
1JS70-8-8	1/2 13/16x16	1/2	2.65	67	13/16	15/16	1.44	37
1JS70-12-8	3/4 1-3/16x12	1/2	2.90	74	1-1/8	1-3/8	1.69	43
1JS70-12-10	3/4 1-3/16x12	5/8	3.10	79	1-1/8	1-3/8	1.85	47



D

1J770

Female Seal-Lok® - Swivel - 45° Elbow

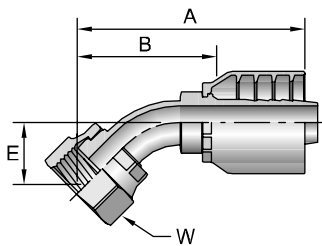
ISO 12151-1 - SWE45



#			A		E			B	
Part Number	Thread inch	Hose I.D. inch	inch	mm	inch	mm	inch	inch	mm
1J770-10-10	5/8 1x14	5/8	3.08	78	0.63	16	1-1/8	1.83	46

E

1J970

Female Seal-Lok® - Swivel - 90° Elbow - Short Drop
 ISO 12151-1 - SWES90

# Part Number	Thread		Hose I.D. inch	A		E		W inch	B	
	inch	mm		inch	mm	inch	mm		inch	mm
1J970-8-8	1/2	13/16x16	1/2	2.59	66	1.14	29	15/16	1.38	35
1J970-12-8	3/4	1-3/16x12	1/2	3.21	82	1.88	48	1-3/8	2.00	51

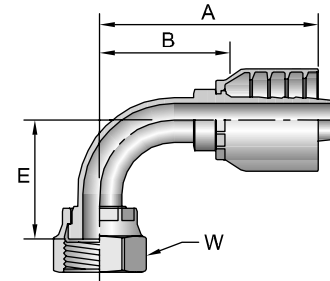

1J570

Female Seal-Lok® - Swivel - 90° Elbow - Medium Drop
 ISO 12151-1 - SWEM90

# Part Number	Thread		Hose I.D. inch	A		E		W inch	B	
	inch	mm		inch	mm	inch	mm		inch	mm
1J570-10-10	5/8	1x14	5/8	2.88	73	1.85	47	1-1/8	1.63	41

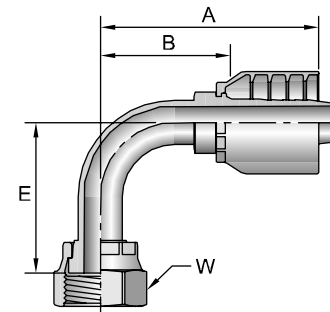

1J170

Female Seal-Lok® - Swivel - 90° Elbow - Long Drop
 ISO 12151-1 - SWEL90

# Part Number	Thread		Hose I.D. inch	A		E		W inch	B	
	inch	mm		inch	mm	inch	mm		inch	mm
1J170-8-8	1/2	13/16x16	1/2	2.59	66	2.52	65	15/16	1.38	35
1J170-10-10	5/8	1x14	5/8	2.88	73	2.76	70	1-1/8	1.63	41

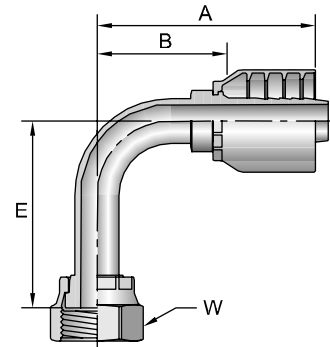



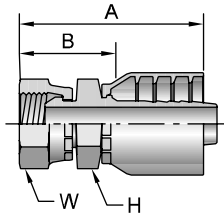

A



1GU70

Female BSP Parallel Pipe - Swivel - (60° Cone)

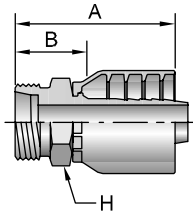

#			A				B	
Part Number	Thread	Hose I.D.	inch	mm	H	W	inch	mm
1GU70-6-6	3/8x19	3/8	2.45	62	22	NA	1.55	39
1GU70-8-8	1/2x14	1/2	2.82	72	27	NA	1.61	41

B



1FG70

Male French Gaz Series - Rigid - (24° Cone)

#			A				B	
Part Number	Thread	Hose I.D.	inch	mm	inch	mm	inch	mm
1FG70-21-10	21 M30x1,5	5/8	2.87	73	1.18	30	1.62	41

C

D

E

10C70

Female Metric S - Swivel - 45° Elbow - (24° Cone with O-Ring)
 ISO 12151-2 - SWE45

# Part Number	Thread mm	Hose I.D. inch	A		E		W mm	B	
			inch	mm	inch	mm		inch	mm
10C70-12-6	12 M20x1,5	3/8	2.72	69	0.79	20	24	1.57	40
10C70-16-8	16 M24x1,5	1/2	3.27	83	0.94	24	30	1.89	48
10C70-20-10	20 M30x2	5/8	3.58	91	0.98	25	36	2.05	52

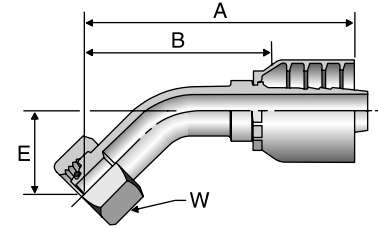

11C70

Female Metric S - Swivel - 90° Elbow - (24° Cone with O-Ring)
 ISO 12151-2 - SWE

# Part Number	Thread mm	Hose I.D. inch	A		E		W mm	B	
			inch	mm	inch	mm		inch	mm
11C70-12-6	12 M20X1,5	3/8	2.64	67	1.46	37	24	1.50	38
11C70-20-10	20 M30X2	5/8	3.11	79	1.89	48	36	1.57	40

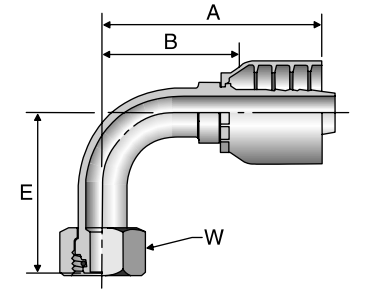

19270

Female BSP Parallel Pipe - Swivel - (60° Cone)
 ISO 228-1

# Part Number	Thread inch	Hose I.D. inch	A		C		W mm	B	
			inch	mm	inch	mm		inch	mm
19270-6-6	3/8x19	3/8	1.93	49	0.28	7	22	0.79	20
19270-8-8	1/2x14	1/2	2.24	57	0.28	7	27	0.87	22
19270-10-10	5/8x14	5/8	2.24	57	0.35	9	30	0.83	21
19270-12-10	3/4x14	5/8	2.40	61	0.35	9	32	0.87	22

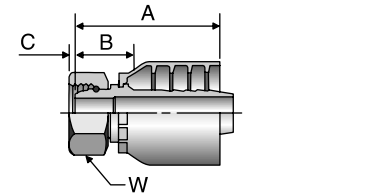

1B170

Female BSP Parallel pipe - Swivel- 45° Elbow - (60° Cone)
 ISO 228-1

# Part Number	Thread inch	Hose I.D. inch	A		E		W mm	B	
			inch	mm	inch	mm		inch	mm
1B170-8-8	1/2x14	1/2	3.11	79	0.79	20	27	1.77	45

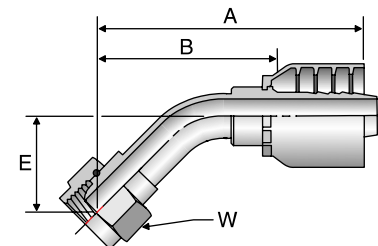

A

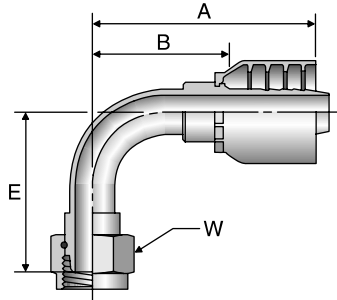

1B270

Female BSP Parallel Pipe - Swivel - 90° Elbow - (60° Cone)
 ISO 228-1

# Part Number	Thread inch	Hose I.D. inch	A		E		W mm	B	
			inch	mm	inch	mm		inch	mm
1B270-8-8	1/2x14	1/2	2.76	70	1.54	39	27	1.38	35
1B270-10-10	5/8x14	5/8	3.07	78	1.81	46	30	1.61	41
1B270-12-10	3/4x14	5/8	3.19	81	1.65	42	32	1.61	41

B

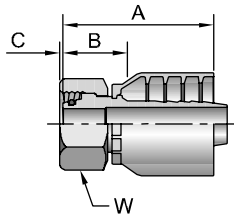

1C970

Female Metric S - Swivel - (24° Cone with O-Ring)

# Part Number	Thread mm		Hose I.D. inch	A		C		W mm	B	
	mm	inch		inch	mm	inch	mm		inch	mm
1C970-12-6	12	M20x1,5	3/8	2.03	52	0.03	1	24	1.13	29
1C970-16-8	16	M24x1,5	1/2	2.31	59	0.09	2	30	1.10	28
1C970-20-10	20	M30x2	5/8	2.51	64	0.05	1	36	1.26	32

When measuring overall length to end of nut, B + C dimensions must be used to calculate cut-off allowance.

C

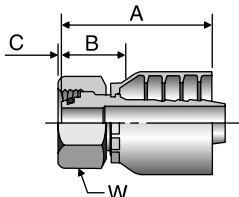

1CA70

Female Metric L - Swivel - (24° Cone with O-Ring)

ISO 12151-2 - SWS

# Part Number	Thread mm		Hose I.D. inch	A		C		W mm	B	
	mm	inch		inch	mm	inch	mm		inch	mm
1CA70-12-6	12	M18x1,5	3/8	2.09	53	0.04	1	22	0.94	24
1CA70-15-8	15	M22x1,5	1/2	2.09	62	0.07	2	22	0.94	27
1CA70-18-10	18	M26x1,5	5/8	2.44	62	0.02	0.5	32	1.02	26

D

1CE70

Female Metric L - Swivel - 45° Elbow - (24° Cone with O-Ring)

ISO 12151-2 - SWE45

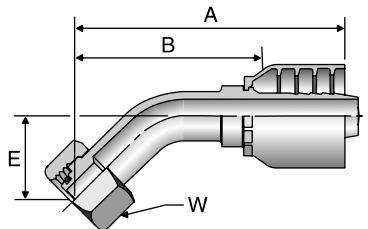

# Part Number	Thread mm		Hose I.D. inch	A		E		W mm	B	
	mm	inch		inch	mm	inch	mm		inch	mm
1CE70-18-10	18	M26x1,5	5/8	3.58	91	0.98	25	32	2.05	52

E

1CF70

Female Metric L - Swivel - 90° Elbow - (24° Cone with O-Ring)

ISO 12151-2 - SWE

# Part Number	Thread mm	Hose I.D. inch	A		E		W mm	B	
			inch	mm	inch	mm		inch	mm
1CF70-15-8	15 M22x1,5	1/2	2.91	74	1.77	45	27	1.54	39
1CF70-18-10	18 M26x1,5	5/8	3.11	79	1.93	49	32	1.65	42

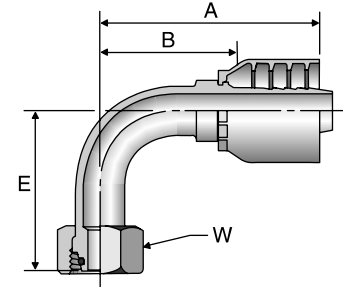

1D270

Male Metric S - Rigid - (24° Cone)

ISO 12151-2

# Part Number	Thread mm	Hose I.D. inch	A		H mm	B	
			inch	mm		inch	mm
1D270-16-8	16 M24x1,5	1/2	2.44	62	24	1.10	28
1D270-20-10	20 M30x2	5/8	2.95	75	30	1.26	32

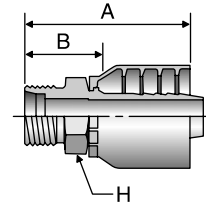

1D970

Male BSP Parallel Pipe - Rigid - (60° Cone)

ISO 228-1

# Part Number	Thread inch	Hose I.D. inch	A		H mm	B	
			inch	mm		inch	mm
1D970-8-8	1/2x14	1/2	2.44	62	27	1.10	28

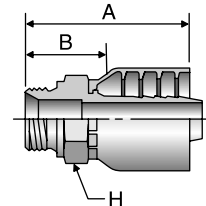

A

B

C

D

E

A

B

C

D

E