

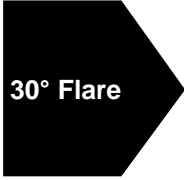









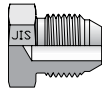

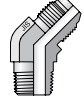
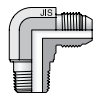
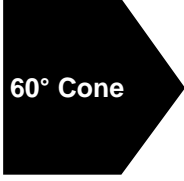

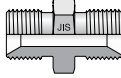
# JIS Fittings

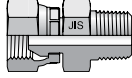
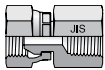
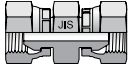
H

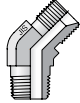
|   |   |  |  |   |   |
|---|---|--|--|---|---|
|  <p><b>30° Flare</b></p>                             | <p><b>F3T4</b><br/>BSPT / 30° Flare</p>  <p>H5</p> | <p><b>PNMT4</b><br/>Plug</p>  <p>H5</p> | <p><b>FNMT4</b><br/>Cap</p>  <p>H5</p>            | <p><b>V3T4</b><br/>BSPT / 30° Flare</p>  <p>H5</p> | <p><b>C3T4</b><br/>BSPT / 30° Flare</p>  <p>H5</p>   |
|  <p><b>60° Cone</b></p>                              | <p><b>F3P4</b><br/>BSPT / 60° Cone</p>  <p>H5</p>  | <p><b>HP4</b><br/>Union</p>  <p>H6</p>  | <p><b>G3P4</b><br/>BSPT / 60° Cone</p>  <p>H6</p> | <p><b>PNMP4</b><br/>Plug</p>  <p>H6</p>            | <p><b>F63P4</b><br/>60° Swivel / BSPT</p>  <p>H6</p> |
| <p><b>G63P4</b><br/>60° Swivel / BSPT</p>  <p>H6</p> | <p><b>HP46</b><br/>Union Swivel</p>  <p>H6</p>     | <p><b>FNMP4</b><br/>Cap</p>  <p>H7</p>  | <p><b>C3P4</b><br/>BSPT / 60° Cone</p>  <p>H7</p> | <p><b>V3P4</b><br/>BSPT / 60° Cone</p>  <p>H7</p>  |   |
|  <p><b>B2351 Port</b></p>                           | <p><b>P47OMN</b><br/>Hex Head Plug</p>  <p>H7</p>  |  |  |   |   |

**O-Rings and Seals** (Shown in Section N)

|   |  |
|---|--|
|  <p><b>JIS O-Rings and Seals</b></p> | <p><b>JIS B2351 O-Ring</b></p>  <p>N7</p> |
|---|--|

Dimensions and pressures for reference only, subject to change.

## JIS Fittings

Parker introduced Japanese Industrial Standard (JIS) adapters in the early 1990s to address market requirements for OEM and replacement fittings. These fittings are typically used as hose adapters on equipment designed and/or manufactured in Japan and Korea. Parker's JIS adapters are designed with 30° flare and 60° cone connections and typically incorporate BSP threads.

Parker JIS adapters are designed with BSPP and BSPT port ends and two styles of hose ends: T4 (30° flare, BSPP threads) and P4 (60° cone, BSPP threads). Two additional Parker series of fittings, KA (Komatsu flare) and K4 (BS B5200) adapters, are similar to JIS style fittings and appear in sections I and J of this catalog.

The T4 and P4 interfaces, as shown in Fig. H1, provide end user flexibility of connecting to the most common Parker hose ends available as listed in Table H1.

Parker's JIS adapter offering that uses the BSPP port connection are manufactured in accordance with the JIS B2351 type "O" port connection which is commonly used for higher pressure systems. Fig. H2 illustrates this port connection and Table H2 shows appropriate JIS B2351 O-rings and dash sizes.

It should be noted that Parker offers two very similar cone style BSPP adapters — P4 and K4. Parker's K4 (60 cone, BSPP) fittings conform to BS5200, while Parker's JIS cone adapters meet JIS B8363 specifications. **These fittings, while very similar, are not interchangeable.** See the I section of this catalog for more specific information on their differences.



Fig. H1 – JIS T4 and P4 Interfaces

| Adapter Connection End | Mating Parker Hose Fitting Series |
|------------------------|-----------------------------------|
| P4 / P46               | UT, GU, G1, G2                    |
| T4 / T46               | FU                                |

Table H1 – Parker JIS Fittings Hose Adaptability

## Design and Construction

**Construction:** Shaped JIS adapters are manufactured from a hot forged construction. Straight adapters are manufactured from cold drawn barstock.

**Threads:** The standard JIS products are manufactured with the thread forms listed below:

BSPP Threads: ISO 228-1 G, JIS B 0202,  
 BSPT Threads: ISO 7/1, JIS B 0203

**Identification:** All Parker JIS fittings are stamped with "JIS" for positive identification and differentiation from similar style fittings.

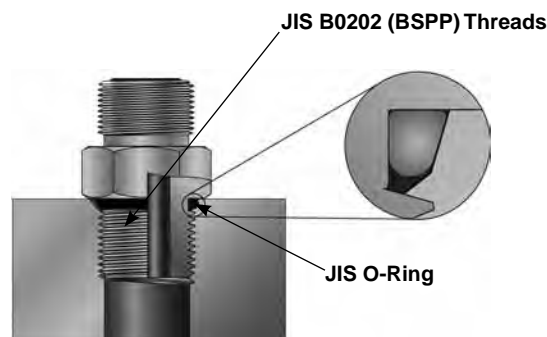

Fig. H2 – JIS B2351 Type "O" Port Connection

## Reference Locations

**Dynamic Pressure Ratings:** Please refer to the last column of part number tables located on the following pages of this section for the appropriate dynamic pressure ratings.

**Standard Material Specifications:** Please refer to Table U1 located in the Appendix section.

| "G" Thread BSPP per ISO 228-1 JIS B 0202 | Dash Size | Port O-Ring (See Pg. N6) |
|--|-----------|--------------------------|
| 1/8-28                                   | 2         | P8                       |
| 1/4-19                                   | 4         | P11                      |
| 3/8-19                                   | 6         | P14                      |
| 1/2-14                                   | 8         | P18                      |
| 3/4-14                                   | 12        | P24                      |
| 1-11                                     | 16        | P29                      |

Table H2 – JIS B2351 Port Threads and O-Rings as shown in Fig. H2

Dimensions and pressures for reference only, subject to change.

## JIS Ends

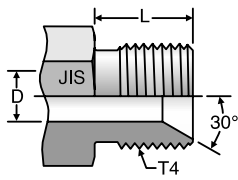

**JIS Male, 60° Seat**

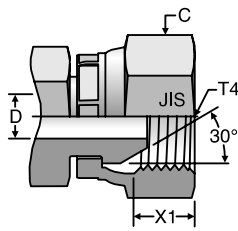

**JIS Swivel  
for 60° Seat**

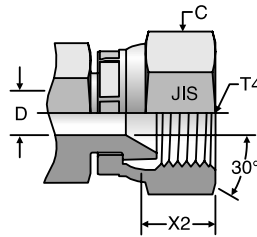

**JIS Swivel  
for 30° Flare**

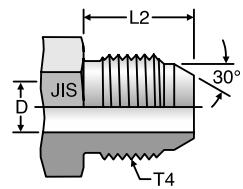

**JIS Male, 30° Flare**

|              | BSPP<br>Thread | Swivel<br>Hex | Drill     | Male<br>Turn Back |            | Assembly<br>Allowance |            |
|--------------|----------------|---------------|-----------|-------------------|------------|-----------------------|------------|
| Dash<br>Size | T4<br>BSPP     | C<br>(in)     | D<br>(in) | L<br>(in)         | L2<br>(in) | X1<br>(in)            | X2<br>(in) |
| <b>4</b>     | 1/4-19         | .75           | 0.177     | .570              | .606       | 0.35                  | 0.36       |
| <b>6</b>     | 3/8-19         | .88           | 0.275     | .609              | .684       | 0.29                  | 0.38       |
| <b>8</b>     | 1/2-14         | 1.06          | 0.433     | .726              | .763       | 0.46                  | 0.53       |
| <b>12</b>    | 3/4-14         | 1.44          | 0.625     | .805              | .842       | 0.55                  | 0.56       |
| <b>16</b>    | 1-11           | 1.63          | 0.828     | .883              | .881       | 0.53                  | 0.58       |

Dimensions and pressures for reference only, subject to change.

### F3T4

Male Connector  
30° Flare / BSPT

Mates with FU Style hose fittings

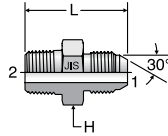

| TUBE FITTING PART # | END SIZE |          | H HEX (in.) | L (in.) | Dynamic Pressure (x 1,000 PSI) |
|---------------------|----------|----------|-------------|---------|--------------------------------|
|                     | 1 BSPP   | 2 BSPT   |             |         | S                              |
|                     |          |          |             |         | 4F3T4                          |
| 4-6F3T4             | 1/4 - 19 | 3/8 - 19 | 0.88        | 1.51    | 5.0                            |
| 6-4F3T4             | 3/8 - 19 | 1/4 - 19 | 0.88        | 1.59    | 5.0                            |
| 6F3T4               | 3/8 - 19 | 3/8 - 19 | 0.88        | 1.59    | 5.0                            |
| 8-6F3T4             | 1/2 - 14 | 3/8 - 19 | 1.06        | 1.70    | 5.0                            |
| 8F3T4               | 1/2 - 14 | 1/2 - 14 | 1.06        | 1.89    | 5.0                            |
| 12F3T4              | 3/4 - 14 | 3/4 - 14 | 1.44        | 2.10    | 4.0                            |
| 16F3T4              | 1-11     | 1-11     | 1.63        | 2.30    | 3.0                            |

### PNMT4

Plug  
30° Flare

Mates with FU Style hose fittings

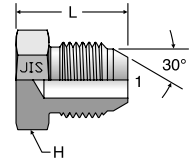

| TUBE FITTING PART # | END SIZE |        | H HEX (mm) | L (in.) | Dynamic Pressure (x 1,000 PSI) |
|---------------------|----------|--------|------------|---------|--------------------------------|
|                     | 1 BSPP   | 2 BSPT |            |         | S                              |
|                     |          |        |            |         | 4PNMT4                         |
| 6PNMT4              | 3/8 - 19 | 19     | 0.97       | 5.0     |                                |
| 8PNMT4              | 1/2 - 14 | 22     | 1.11       | 5.0     |                                |
| 12PNMT4             | 3/4 - 14 | 30     | 1.26       | 4.0     |                                |
| 16PNMT4             | 1-11     | 36     | 1.30       | 3.0     |                                |

### FNMT4

Cap  
30° Flare

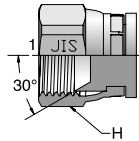

| TUBE FITTING PART # | END SIZE |        | H HEX (in.) | Dynamic Pressure (x 1,000 PSI) |
|---------------------|----------|--------|-------------|--------------------------------|
|                     | 1 BSPP   | 2 BSPT |             | S                              |
|                     |          |        |             | 4FNMT4                         |
| 6FNMT4              | 3/8 - 19 | 0.88   | 5.0         |                                |
| 8FNMT4              | 1/2 - 14 | 1.06   | 5.0         |                                |
| 12FNMT4             | 3/4 - 14 | 1.44   | 4.0         |                                |
| 16FNMT4             | 1-11     | 1.63   | 3.0         |                                |

### V3T4

45° Male Elbow  
30° Flare / BSPT

Mates with FU Style hose fittings

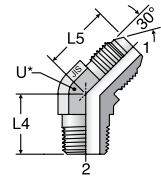

\* Across wrench flats

| TUBE FITTING PART # | END SIZE |          | L4 (in.) | L5 (in.) | U (in.) | Dynamic Pressure (x 1,000 PSI) |
|---------------------|----------|----------|----------|----------|---------|--------------------------------|
|                     | 1 BSPP   | 2 BSPT   |          |          |         | S                              |
|                     |          |          |          |          |         | 4V3T4                          |
| 6V3T4               | 3/8 - 19 | 3/8 - 19 | 0.87     | 0.97     | 0.75    | 5.0                            |
| 8V3T4               | 1/2 - 14 | 1/2 - 14 | 1.06     | 1.10     | 0.88    | 5.0                            |
| 12V3T4              | 3/4 - 14 | 3/4 - 14 | 1.18     | 1.24     | 1.06    | 4.0                            |
| 16V3T4              | 1-11     | 1-11     | 1.37     | 1.26     | 1.31    | 3.0                            |

### C3T4

Male Elbow  
30° Flare / BSPT

Mates with FU Style hose fittings

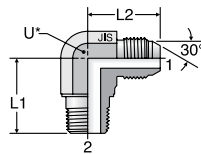

\* Across wrench flats

| TUBE FITTING PART # | END SIZE |          | L1 (in.) | L2 (in.) | U (in.) | Dynamic Pressure (x 1,000 PSI) |
|---------------------|----------|----------|----------|----------|---------|--------------------------------|
|                     | 1 BSPP   | 2 BSPT   |          |          |         | S                              |
|                     |          |          |          |          |         | 4C3T4                          |
| 6C3T4               | 3/8 - 19 | 3/8 - 19 | 1.18     | 1.14     | 0.75    | 5.0                            |
| 8C3T4               | 1/2 - 14 | 1/2 - 14 | 1.42     | 1.33     | 0.88    | 5.0                            |
| 12C3T4              | 3/4 - 14 | 3/4 - 14 | 1.69     | 1.50     | 1.06    | 4.0                            |
| 16C3T4              | 1-11     | 1-11     | 1.97     | 1.74     | 1.31    | 3.0                            |

### F3P4

Male Connector  
60° Cone / BSPT

Mates with GU, G1 and G2 Style hose fittings

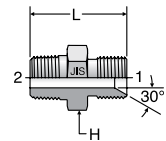

| TUBE FITTING PART # | END SIZE |          | H HEX (in.) | L (in.) | Dynamic Pressure (x 1,000 PSI) |
|---------------------|----------|----------|-------------|---------|--------------------------------|
|                     | 1 BSPP   | 2 BSPT   |             |         | S                              |
|                     |          |          |             |         | 4F3P4                          |
| 6F3P4               | 3/8 - 19 | 3/8 - 19 | 0.88        | 1.50    | 5.0                            |
| 8F3P4               | 1/2 - 14 | 1/2 - 14 | 1.06        | 1.81    | 5.0                            |
| 12F3P4              | 3/4 - 14 | 3/4 - 14 | 1.44        | 2.05    | 4.0                            |
| 16F3P4              | 1-11     | 1-11     | 1.63        | 2.28    | 3.0                            |

Dimensions and pressures for reference only, subject to change.

### HP4

Union  
60° Cone

Mates with GU, G1 and G2 Style hose fittings

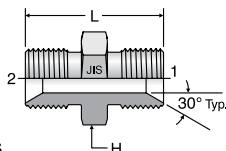

| TUBE FITTING PART # | END SIZE   |  | H HEX (in.) | L (in.) | Dynamic Pressure (x 1,000 PSI) |
|---------------------|------------|--|-------------|---------|--------------------------------|
|                     | 1 & 2 BSPP |  |             |         | S                              |
| 4HP4                | 1/4 - 19   |  | 0.75        | 1.34    | 5.0                            |
| 6HP4                | 3/8 - 19   |  | 0.88        | 1.50    | 5.0                            |
| 8HP4                | 1/2 - 14   |  | 1.06        | 1.81    | 5.0                            |
| 12HP4               | 3/4 - 14   |  | 1.44        | 2.05    | 4.0                            |
| 16HP4               | 1-11       |  | 1.63        | 2.28    | 3.0                            |

### G3P4

Female Connector  
60° Cone / BSPT

Mates with GU, G1 and G2 Style hose fittings

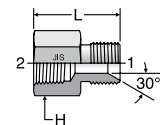

| TUBE FITTING PART # | END SIZE |          | H HEX (in.) | L (in.) | Dynamic Pressure (x 1,000 PSI) |
|---------------------|----------|----------|-------------|---------|--------------------------------|
|                     | 1 BSPP   | 2 BSPT   |             |         | S                              |
| 4G3P4               | 1/4 - 19 | 1/4 - 19 | 0.75        | 1.22    | 5.0                            |
| 6G3P4               | 3/8 - 19 | 3/8 - 19 | 0.88        | 1.34    | 5.0                            |
| 8G3P4               | 1/2 - 14 | 1/2 - 14 | 1.06        | 1.58    | 5.0                            |
| 12G3P4              | 3/4 - 14 | 3/4 - 14 | 1.44        | 1.73    | 4.0                            |
| 16G3P4              | 1-11     | 1-11     | 1.63        | 1.93    | 3.0                            |

### PNMP4

Plug  
60° Cone

Mates with GU, G1 and G2 Style hose fittings

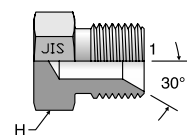

| TUBE FITTING PART # | END SIZE |  | H HEX (mm) | Dynamic Pressure (x 1,000 PSI) |
|---------------------|----------|--|------------|--------------------------------|
|                     | 1 BSPP   |  |            | S                              |
| 4FNMP4              | 1/4 - 19 |  | 17         | 5.0                            |
| 6FNMP4              | 3/8 - 19 |  | 19         | 5.0                            |
| 8FNMP4              | 1/2 - 14 |  | 22         | 5.0                            |
| 12FNMP4             | 3/4 - 14 |  | 30         | 4.0                            |
| 16FNMP4             | 1-11     |  | 36         | 3.0                            |

### F63P4

Swivel Male Connector  
60° Swivel / BSPT

Mates with UT Style hose fittings

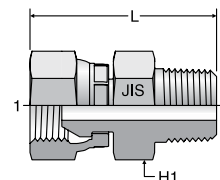

| TUBE FITTING PART # | END SIZE |          | H1 HEX (in.) | L (in.) | Dynamic Pressure (x 1,000 PSI) |
|---------------------|----------|----------|--------------|---------|--------------------------------|
|                     | 1 BSPP   | 2 BSPT   |              |         | S                              |
| 4F63P4              | 1/4 - 19 | 1/4 - 19 | 0.75         | 1.73    | 5.0                            |
| 6F63P4              | 3/8 - 19 | 3/8 - 19 | 0.88         | 1.94    | 5.0                            |
| 8F63P4              | 1/2 - 14 | 1/2 - 14 | 1.06         | 2.25    | 5.0                            |
| 12F63P4             | 3/4 - 14 | 3/4 - 14 | 1.44         | 2.55    | 4.0                            |
| 16F63P4             | 1-11     | 1-11     | 1.63         | 2.77    | 3.0                            |

### G63P4

Swivel Female Connector  
60° Swivel / BSPT

Mates with UT Style hose fittings

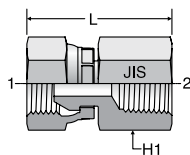

| TUBE FITTING PART # | END SIZE |          | H1 HEX (in.) | L (in.) | Dynamic Pressure (x 1,000 PSI) |
|---------------------|----------|----------|--------------|---------|--------------------------------|
|                     | 1 BSPP   | 2 BSPT   |              |         | S                              |
| 4G63P4              | 1/4 - 19 | 1/4 - 19 | 0.75         | 1.61    | 5.0                            |
| 6G63P4              | 3/8 - 19 | 3/8 - 19 | 0.88         | 1.78    | 5.0                            |
| 8G63P4              | 1/2 - 14 | 1/2 - 14 | 1.06         | 2.02    | 5.0                            |
| 12G63P4             | 3/4 - 14 | 3/4 - 14 | 1.44         | 2.20    | 4.0                            |
| 16G63P4             | 1-11     | 1-11     | 1.63         | 2.52    | 3.0                            |

### HP46

Swivel Union Connector  
60° Swivel

Mates with UT Style hose fittings

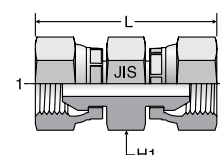

| TUBE FITTING PART # | END SIZE   |  | H1 HEX (in.) | L (in.) | Dynamic Pressure (x 1,000 PSI) |
|---------------------|------------|--|--------------|---------|--------------------------------|
|                     | 1 & 2 BSPP |  |              |         | S                              |
| 4HP46               | 1/4 - 19   |  | 0.75         | 2.12    | 5.0                            |
| 6HP46               | 3/8 - 19   |  | 0.88         | 2.37    | 5.0                            |
| 8HP46               | 1/2 - 14   |  | 1.06         | 2.73    | 5.0                            |
| 12HP46              | 3/4 - 14   |  | 1.44         | 2.96    | 4.0                            |
| 16HP46              | 1-11       |  | 1.63         | 3.24    | 3.0                            |

Dimensions and pressures for reference only, subject to change.



### FNMP4

Cap  
60° Cone

Mates with UT Style hose fittings

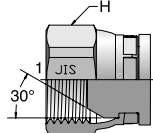

| TUBE FITTING PART # | END SIZE |          | H HEX (in.) | Dynamic Pressure (x 1,000 PSI) |
|---------------------|----------|----------|-------------|--------------------------------|
|                     | 1 BSPP   | 2 BSPT   |             | S                              |
|                     |          |          | 4FNMP4      | 1/4 - 19                       |
| 6FNMP4              | 3/8 - 19 | 3/8 - 19 | 0.88        | 5.0                            |
| 8FNMP4              | 1/2 - 14 | 1/2 - 14 | 1.06        | 5.0                            |
| 12FNMP4             | 3/4 - 14 | 3/4 - 14 | 1.44        | 4.0                            |
| 16FNMP4             | 1-11     | 1-11     | 1.63        | 3.0                            |

### C3P4

90° Male Elbow  
60° Cone / BSPT

Mates with GU, G1 and G2 Style hose fittings

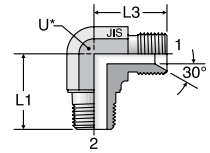

\* Across wrench flats

| TUBE FITTING PART # | END SIZE |          | L1 (in.) | L3 (in.) | U (in.)  | Dynamic Pressure (x 1,000 PSI) |
|---------------------|----------|----------|----------|----------|----------|--------------------------------|
|                     | 1 BSPP   | 2 BSPT   |          |          |          | S                              |
|                     |          |          | 4C3P4    | 1/4 - 19 | 1/4 - 19 | 1.00                           |
| 6C3P4               | 3/8 - 19 | 3/8 - 19 | 1.18     | 1.14     | 0.75     | 5.0                            |
| 8C3P4               | 1/2 - 14 | 1/2 - 14 | 1.42     | 1.28     | 0.88     | 5.0                            |
| 12C3P4              | 3/4 - 14 | 3/4 - 14 | 1.69     | 1.56     | 1.06     | 4.0                            |
| 16C3P4              | 1-11     | 1-11     | 1.97     | 1.74     | 1.31     | 3.0                            |

### V3P4

45° Male Elbow  
60° Cone / BSPT

Mates with GU, G1 and G2 Style hose fittings

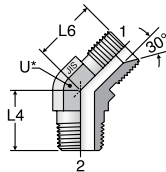

| TUBE FITTING PART # | END SIZE |          | L4 (in.) | L6 (in.) | U (in.)  | Dynamic Pressure (x 1,000 PSI) |
|---------------------|----------|----------|----------|----------|----------|--------------------------------|
|                     | 1 BSPP   | 2 BSPT   |          |          |          | S                              |
|                     |          |          | 4V3P4    | 1/4 - 19 | 1/4 - 19 | 0.75                           |
| 6V3P4               | 3/8 - 19 | 3/8 - 19 | 0.87     | 0.91     | 0.75     | 5.0                            |
| 8V3P4               | 1/2 - 14 | 1/2 - 14 | 1.06     | 1.05     | 0.88     | 5.0                            |
| 12V3P4              | 3/4 - 14 | 3/4 - 14 | 1.18     | 1.18     | 1.06     | 4.0                            |
| 16V3P4              | 1-11     | 1-11     | 1.37     | 1.30     | 1.31     | 3.0                            |

### P47OMN

Plug

Hex head plug for JIS B2351

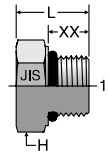

| TUBE FITTING PART # | END SIZE |          | H HEX (mm) | L (mm)   | XX (mm)  | Dynamic Pressure (x 1,000 PSI) |
|---------------------|----------|----------|------------|----------|----------|--------------------------------|
|                     | 1 BSPP   | 2 BSPT   |            |          |          | S                              |
|                     |          |          | 4P47OMN    | 1/4 - 19 | 1/4 - 19 | 19                             |
| 6P47OMN             | 3/8 - 19 | 3/8 - 19 | 22         | 20.0     | 11.2     | 5.0                            |
| 8P47OMN             | 1/2 - 14 | 1/2 - 14 | 27         | 24.1     | 14.5     | 5.0                            |
| 12P47OMN            | 3/4 - 14 | 3/4 - 14 | 36         | 26.9     | 14.5     | 4.0                            |
| 16P47OMN            | 1-11     | 1-11     | 41         | 31.0     | 18.5     | 3.0                            |

Dimensions and pressures for reference only, subject to change.

